



THE PARQUET MANUFACTURER

- Glanwood-Parquet
- Twin-Parquet
- Strip-Parquet
- 3-Layer-Parquet
- Solid-Wood-Parquet
- Designline
- Stair Nosing

# PRICELIST

— INTERNATIONAL —

As of 1/2024 | Valid from 1. January 2024

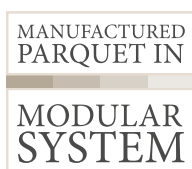

# PARQUET IN THE MODULAR PRINCIPLE

## **This is how it works:**

Select the format of the parquet planks and the desired grading. Then determine the surface structure and the color finish.

## **All prices incl. light brushing & final oiling:**

To make your choice easier our most popular configuration is included in the price tables: A light brushing and final oiling with Rubio Monocoat® in the color of your choice.

## **You'd like a different brushing or stained parquet?**

There is a table with markups and markdowns on each product page to calculate your individual parquet selection.

After you have chosen and combined all the options, our team start producing your individually compiled parquet flooring.

*Manufacture parquet  
in the modular system:*

- + Raw parquet*
- + Surface treatment*
- + Color finishing  
(optional stain/color oil)*

# CONTENTS

|           |   |
|-----------|---|
| <b>4</b>  | <b>GRADINGS</b>                                   |
| <b>6</b>  | <b>FORMATS</b>                                    |
|           | <b>GLANWOOD PARQUET</b>                           |
| <b>8</b>  | Floorboards                                       |
| <b>9</b>  | Strip-Parquet                                     |
|           | <b>TWIN-PARKETT</b>                               |
| <b>11</b> | Twin-Parquet 10                                   |
| <b>12</b> | Twin-Parquet 13                                   |
| <b>13</b> | Twin-Parquet 18                                   |
|           | <b>TWIN-STAB-PARKETT</b>                          |
| <b>17</b> | Twin-Strip-Parquet / Herringbone                  |
| <b>19</b> | <b>LAYING PATTERNS</b>                            |
|           | <b>SOLID WOOD</b>                                 |
| <b>21</b> | Floorboards                                       |
| <b>25</b> | Strip-Parquet                                     |
|           | <b>STRIP PARQUET</b>                              |
| <b>28</b> | Strip-Parquet TRIO/Herringbone 90°                |
| <b>30</b> | Strip-Parquet TRIO/Herringbone 90° (Object)       |
| <b>31</b> | Strip-Parquet TRIO Chevron/French Herringbone     |
| <b>33</b> | <b>PARQUET ADHESIVE</b>                           |
|           | <b>3-LAYER-PARQUET</b>                            |
| <b>35</b> | 3-Layer-Parquet 5G-C                              |
|           | <b>DESIGNLINE</b>                                 |
| <b>40</b> | Castleline  |
| <b>42</b> | Fishline  |
| <b>44</b> | Spindle   |
| <b>46</b> | Sandclock   |
|           | <b>STAIR NOSING</b>                               |
| <b>49</b> | Twin-Parquet                                      |
| <b>50</b> | 3-Layer-Parquet                                   |
|           | <b>SURFACES AND FINISHING</b>                     |
| <b>52</b> | Raw Wood Look (Rubio Monocoat®)                   |
| <b>53</b> | Oiled Surfaces (Osmo®)                            |
| <b>54</b> | Raw Wood Look (Saicos®)                           |
| <b>55</b> | Lacquer Surface (Saicos®)                         |
| <b>56</b> | Surfaces  |
| <b>57</b> | Pre-Aging Effect                                  |
| <b>58</b> | Nano Staining                                     |
| <b>59</b> | Color Oils  |
| <b>64</b> | <b>CARE &amp; CLEANING</b>                        |
| <b>66</b> | <b>POINT OF SALE</b>                              |
| <b>67</b> | <b>GENERAL DELIVERY &amp; TERMS OF CONDITIONS</b> |



# GRADINGS

General description on the color Pure

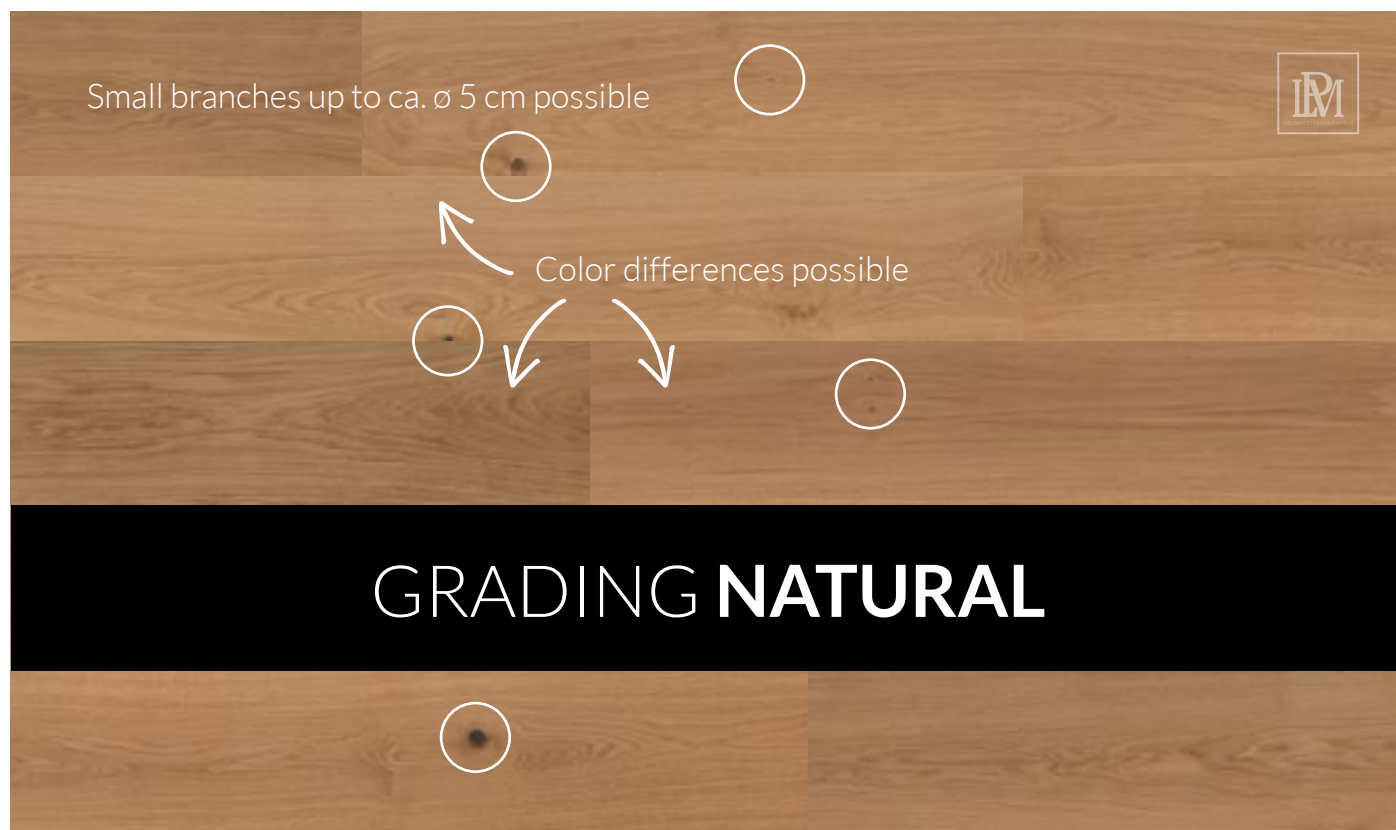
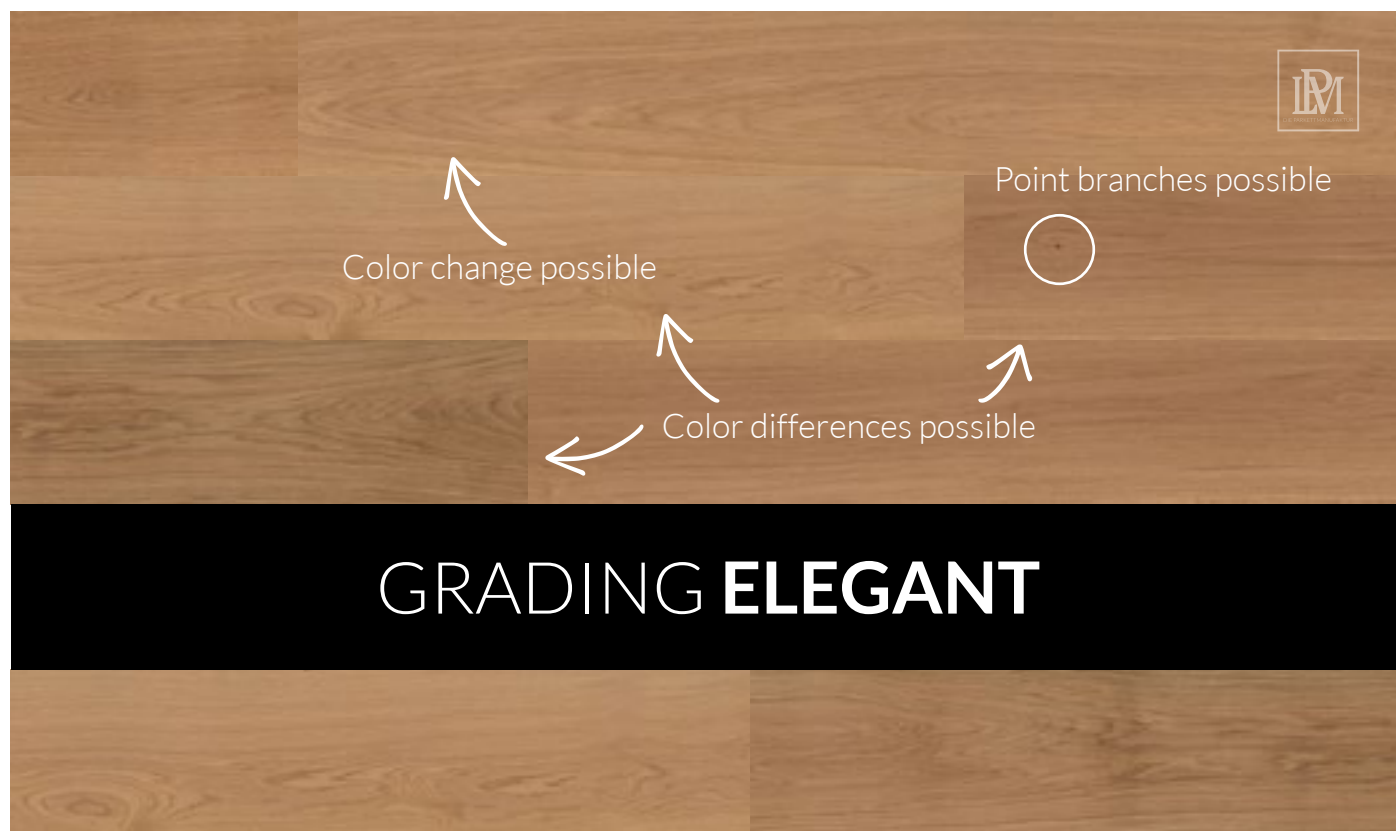



Branches up to ca.  $\varnothing$  5-8 cm possible



Color differences possible

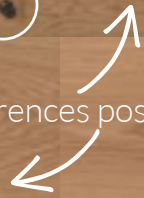

Cracks possible



## GRADING MARKANT



Branches up to ca.  $\varnothing$  5-10 cm possible



Color differences possible

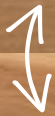

Cracks possible



Sapwood possible



## GRADING RUSTIC



# FORMATS

The spatial effect is influenced by the selection of the parquet format:

Small rooms can be visually enlarged or particularly large rooms given more structure. The choice of parquet can create a balanced ambience or make a room appear more lively.

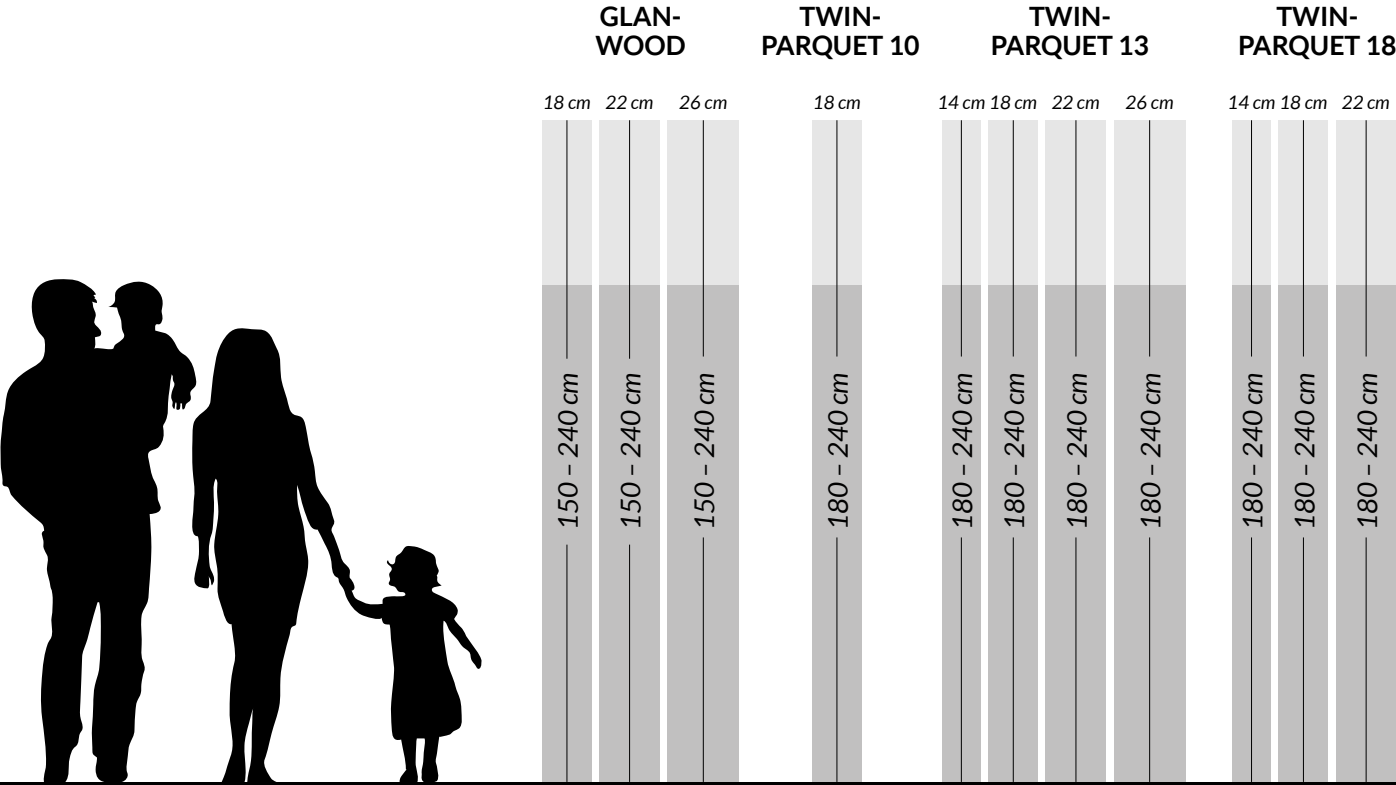

THICKNESS      ca. 16 mm      ca. 10 mm      ca. 13 mm      ca. 18 mm



**Best quality at fair prices:**

You can obtain additional formats from our parquet factory upon request.

**FSC®-certification:**

Available products on request.

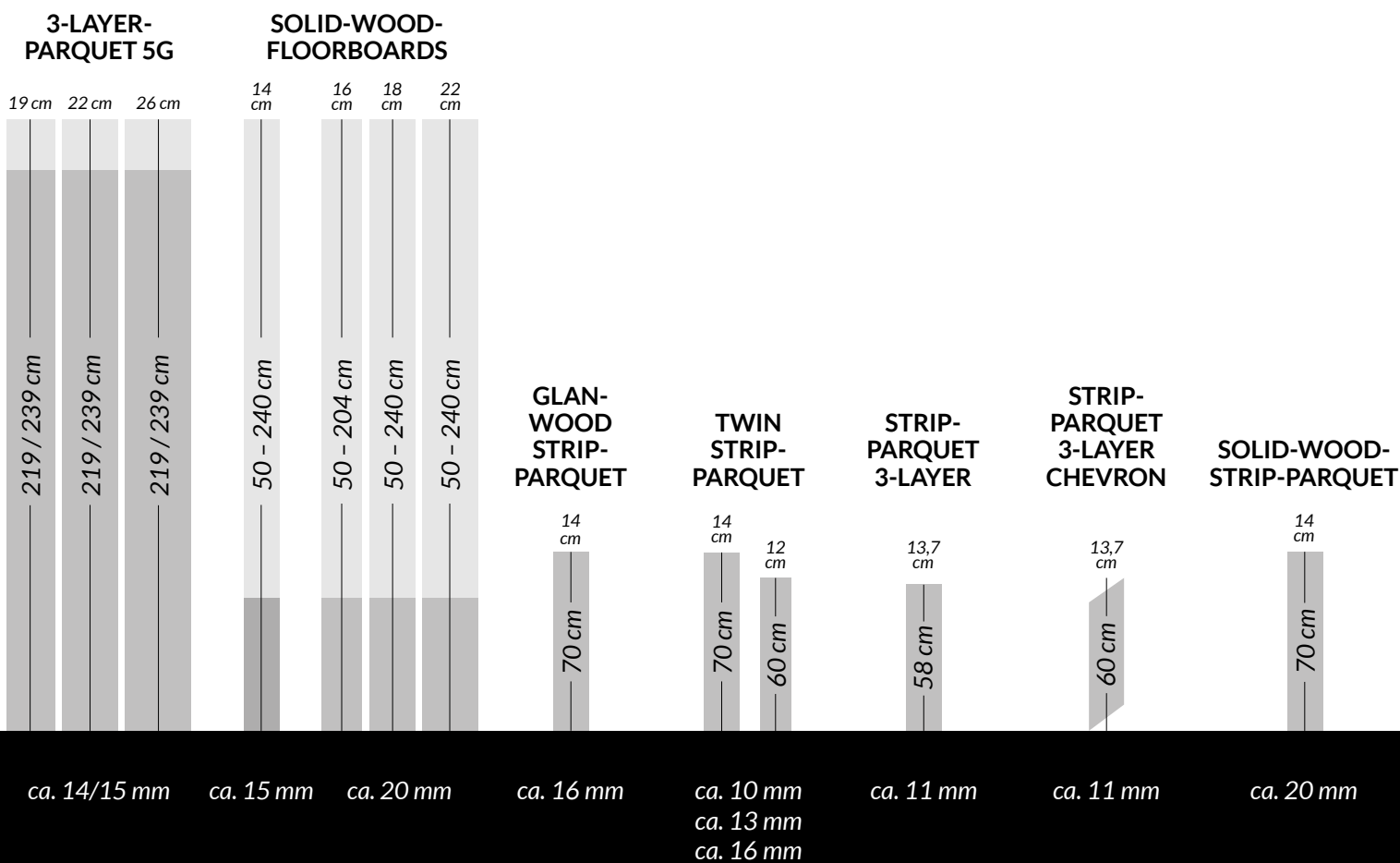

Discover more information about the construction of our parquet here:



The logo consists of the letters 'IPM' in a stylized, serif font. The 'I' and 'M' are a light tan color, while the 'P' is a dark brown color, overlapping the 'I' and 'M'.

THE PARQUET MANUFACTURER

## GLANWOOD



HAUKE (FGW1)



ASTRID (FGW2)



OLE (FGW3)



NEELE (FGW4)



SVANTJE (FGW5)



MICHEL (FGW6)



FRAUKE (FGW7)



THIES (FGW8)



# GLANWOOD-PARQUET

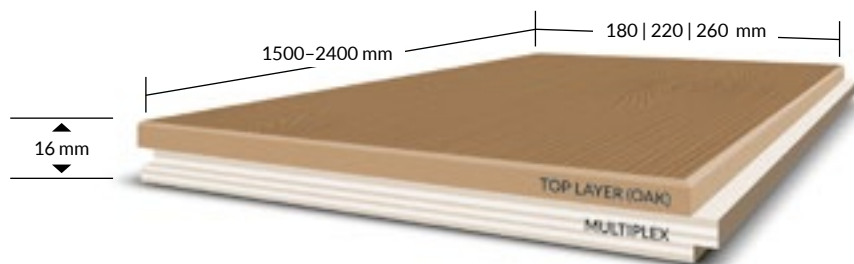

## CONSTRUCTION

1500-2400 mm (10 % shorter lengths possible)  
ca. 16 mm | ± 3/4 mm top layer | ca. 12 mm plywood support (birch)  
edges chamfered 2V | tongue and groove

| ARTICLE NO. | PRODUCT DESCRIPTION | DIMENSIONS | PRICES INCLUDE<br>LIGHT BRUSHING/END OILED |
|-------------|---------------------|------------|--|
|             |                     |            | €/m <sup>2</sup> net                       |
| TPG16180    | Glanwood 180        | 180 mm     | 107,09                                     |
| TPG16220    | Glanwood 220        | 220 mm     | 114,89                                     |
| TPG16260    | Glanwood 260        | 260 mm     | 122,69                                     |

! Shorter lengths are possible upon request. Due to the different formats, deviations may occur between the ordered and the final produced goods. This slight overdelivery of material amounts to a maximum of 3 % and will be invoiced.

\*Availability of goods on request | \*\*Delivery times of 4-6 weeks possible  
FSC®-Certification: Available products on request.

# GLANWOOD STRIP-PARQUET

## 2-Layer | Herringbone

## CONSTRUCTION

ca. 16 mm | ca. 4 mm top layer (european oak / deep cracks filled) | ca. 12 mm plywood support (birch)  
edges unchamfered | tongue and groove

| ARTICLE NO. | PRODUCT DESCRIPTION                       | DIMENSIONS        | PRICES INCLUDE<br>LIGHT BRUSHING/END OILED |
|-------------|---|-------------------|--|
|             |   |                   | €/m <sup>2</sup> net                       |
| TPG16140    | Glanwood Strip-Parquet / Herringbone 90°* | 16 x 140 x 700 mm | 110,65                                     |

! Herringbone and Hungarian patterns are supplied in the above dimensions with left and right strips.

\*Availability of goods on request | \*\*Delivery times of 4-6 weeks possible  
FSC®-Certification: Available products on request.

### PARQUET OPTIONS IN THE MODULAR PRINCIPLE

■ MADE IN GERMANY

■ ADDITIONAL COLORS are possible for a surcharge of 6,50 €

|         | ARTICLE NO. | SURFACE TREATMENT   |           | €/m <sup>2</sup> net |
|---------|-------------|---|-----------|----------------------|
| FARBTON | FGW1        | Oiling (finally oiled) with Rubio Monocoat® / color Hauke   | Inclusive | 5,73                 |
|         | FGW2        | Oiling (finally oiled) with Rubio Monocoat® / color Astrid  | Inclusive | 5,73                 |
|         | FGW3        | Oiling (finally oiled) with Rubio Monocoat® / color Ole     | Inclusive | 5,73                 |
|         | FGW4        | Oiling (finally oiled) with Rubio Monocoat® / color Neele   | Inclusive | 5,73                 |
|         | FGW5        | Oiling (finally oiled) with Rubio Monocoat® / color Svantje | Inclusive | 5,73                 |
|         | FGW6        | Oiling (finally oiled) with Rubio Monocoat® / color Michel  | Inclusive | 5,73                 |
|         | FGW7        | Oiling (finally oiled) with Rubio Monocoat® / color Frauke  | Inclusive | 5,73                 |
|         | FGW8        | Oiling (finally oiled) with Rubio Monocoat® / color Thies   | Inclusive | 5,73                 |

! Wood is a natural product - deviations from the listed grading instructions may occur and do not constitute a defect.



IPM

THE PARQUET MANUFACTURER

TWIN-PARKETT



# TWIN-PARQUET 10

## THE RENOVATION FLOORBOARD



### CONSTRUCTION

1800-2400 mm (10 % shorter lengths possible)  
 ca. 10 mm | ca. 4 mm top layer (oak)  
 ca. 6 mm plywood support (birch)  
 quality according to factory standards  
 produced analogously according to DIN EN 13489  
 wood moisture ca. 9 %  
 edges chamfered 2V or 4V | tongue and groove

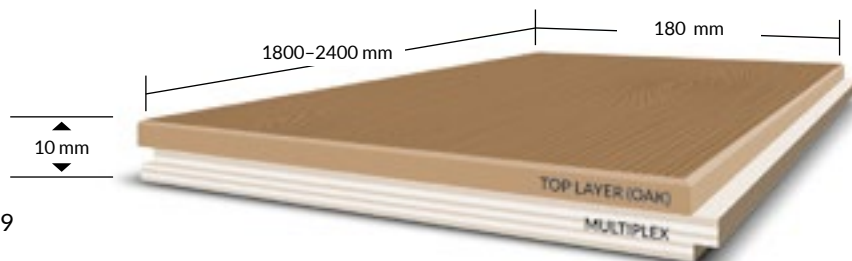

| ARTICLE NO. | PRODUCT DESCRIPTION | DIMENSIONS | PRICES INCLUDE LIGHT BRUSHING/END OILED<br>€/m <sup>2</sup> net |
|-------------|---------------------|------------|---|
| TP10E180    | Oak Elegant*        | 180 mm     | 103,62  |
| TP10N180    | Oak Natural*        | 180 mm     | 88,35   |
| TP10M180    | Oak Markant*        | 180 mm     | 75,28   |
| TP10R180    | Oak Rustic*         | 180 mm     | 71,55   |

! Due to the different formats, there may be deviations between the ordered and the final product. This slight material overdelivery amounts to max. 3 % and will be invoiced.

\*goods available from January 1st, 2023 | \*\*delivery times of 4-6 weeks possible

FSC®-Certification: available products on request

Orders over 100 sqm also available without chamfer or 2V

### PARQUET OPTIONS IN THE MODULAR PRINCIPLE

#### MADE IN GERMANY

All surface treatment and finishing options can be found on page 52 onwards.

#### NOTICE FOR SURFACE TREATMENT

\*Staining only in conjunction with oil



|         | ARTICLE NO. | SURFACE TREATMENT & FINISHING                   |           | €/m <sup>2</sup> net |
|---------|-------------|---|-----------|----------------------|
| SURFACE | ST00        | Sanded  | Discount  | -2,56                |
|         | ST01        | Lightly brushed                                 | Included  | 2,56                 |
|         | ST02        | Medium brushed                                  | Surcharge | +0,88                |
|         | ST03        | Strongly brushed                                | Surcharge | +1,76                |
|         | ST05        | Roughly sawn                                    | Surcharge | +3,53                |
| COLOR   | BXXX/FXXX   | Stained and oiled (end oiled, Rubio Monocoat®)* | Surcharge | +5,82                |
|         | FXXX        | Oiled (end oiled) (Rubio Monocoat®)             | Included  | 5,73                 |
|         | FOXX        | Oiled (Osmo 2K Oil)                             | Surcharge | +2,00                |
|         | FRHR        | Raw wood look (Rubio Monocoat®)                 | Surcharge | +6,87                |
|         | FRHS        | Raw wood look (Saicos)                          | Surcharge | +5,00                |
|         | FLAC        | Paint (Saicos)                                  | Surcharge | +6,87                |

| GRADING           | ELEGANT   | NATURAL                         | MARKANT                             | RUSTIC                              |
|-------------------|---|---------------------------------|-------------------------------------|-------------------------------------|
| Appearance        | harmonious                                      | calm                            | lively                              | expressive                          |
| Branches          | point and isolated branches up to ca. ø 5-10 mm | healthy branches ca. ø 15-45 mm | branches and edge branches probable | branches and edge branches probable |
| Cracks            | basically free                                  | basically free                  | few permitted                       | permitted                           |
| Hairline cracks   | occasionally permitted                          | occasionally permitted          | occasionally permitted              | permitted                           |
| Sapwood           | basically free                                  | basically free                  | basically free                      | healthy sapwood ca. 20-30%          |
| Color differences | light, naturally permitted                      | naturally permitted             | permitted                           | permitted                           |
| Putty color       | dark brown                                      | dark brown                      | dark brown                          | dark brown                          |

! Wood is a natural product - deviations from the listed grading instructions may occur and do not constitute a defect.

# TWIN-PARQUET 13



## CONSTRUCTION

1800-2400 mm (10 % shorter lengths possible)  
 ca. 13 mm | ca. 4 mm top layer (oak)  
 ca. 9 mm plywood support (birch)  
 quality according to factory standards  
 produced analogously according to DIN EN 13489  
 wood moisture ca. 9 % | edges chamfered 2V or 4V | tongue and groove

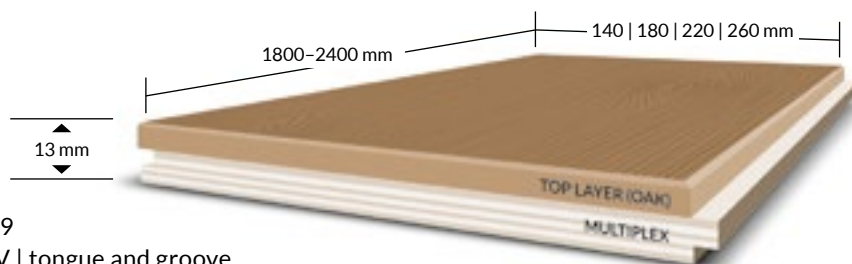

| ARTICLE NO. | PRODUCT DESCRIPTION | DIMENSIONS | PRICES INCLUDE LIGHT BRUSHING/END OILED<br>€/m <sup>2</sup> net |
|-------------|---------------------|------------|---|
| TP13E140    | Oak Elegant*        | 140 mm     | 102,75  |
| TP13N140    | Oak Natural         | 140 mm     | 91,55   |
| TP13M140    | Oak Markant         | 140 mm     | 83,15   |
| TP13R140    | Oak Rustic          | 140 mm     | 79,97   |
| TP13E180    | Oak Elegant*        | 180 mm     | 112,08  |
| TP13N180    | Oak Natural         | 180 mm     | 97,15   |
| TP13M180    | Oak Markant         | 180 mm     | 84,08   |
| TP13R180    | Oak Rustic          | 180 mm     | 80,35   |
| TP13E220    | Oak Elegant*        | 220 mm     | 115,81  |
| TP13N220    | Oak Natural         | 220 mm     | 99,95   |
| TP13M220    | Oak Markant         | 220 mm     | 85,95   |
| TP13R220    | Oak Rustic          | 220 mm     | 81,28   |
| TP13E260    | Oak Elegant*        | 260 mm     | 117,68  |
| TP13N260    | Oak Natural         | 260 mm     | 102,75  |
| TP13M260    | Oak Markant         | 260 mm     | 88,75   |
| TP13R260    | Oak Rustic          | 260 mm     | 82,21   |

**!** Due to the different formats, there may be deviations between the ordered and the final product. This slight material overdelivery amounts to max. 3 % and will be invoiced. stocked goods | \*goods available upon request | \*\*delivery times of 4-6 weeks possible  
 FSC®-Certification: available products on request  
 Orders over 100 sqm also available without chamfer or 2V

## PARQUET OPTIONS IN THE MODULAR PRINCIPLE

**MADE IN GERMANY**  
 All surface treatment and finishing options can be found on page 52 onwards.

**NOTICE FOR SURFACE TREATMENT**  
 \*Staining only in conjunction with oil



|         | ARTICLE NO. | SURFACE TREATMENT & FINISHING                   | €/m <sup>2</sup> net |
|---------|-------------|---|----------------------|
| SURFACE | ST00        | Sanded  | Discount -2,56       |
|         | ST01        | Lightly brushed                                 | Included 2,56        |
|         | ST02        | Medium brushed                                  | Surcharge +0,88      |
|         | ST03        | Strongly brushed                                | Surcharge +1,76      |
|         | ST05        | Roughly sawn                                    | Surcharge +3,53      |
| COLOR   | BXXX/FXXX   | Stained and oiled (end oiled, Rubio Monocoat®)* | Surcharge +5,82      |
|         | FXXX        | Oiled (end oiled) (Rubio Monocoat®)             | Included 5,73        |
|         | FOXX        | Oiled (Osmo 2K Oil)                             | Surcharge +2,00      |
|         | FRHR        | Raw wood look (Rubio Monocoat®)                 | Surcharge +6,87      |
|         | FRHS        | Raw wood look (Saicos)                          | Surcharge +5,00      |
|         | FLAC        | Paint (Saicos)                                  | Surcharge +6,87      |

| GRADING           | ELEGANT   | NATURAL                         | MARKANT                             | RUSTIC                              |
|-------------------|---|---------------------------------|-------------------------------------|-------------------------------------|
| Appearance        | harmonious                                      | calm                            | lively                              | expressive                          |
| Branches          | point and isolated branches up to ca. ø 5-10 mm | healthy branches ca. ø 15-45 mm | branches and edge branches probable | branches and edge branches probable |
| Cracks            | basically free                                  | basically free                  | few permitted                       | permitted                           |
| Hairline cracks   | occasionally permitted                          | occasionally permitted          | occasionally permitted              | permitted                           |
| Sapwood           | basically free                                  | basically free                  | basically free                      | healthy sapwood ca. 20-30%          |
| Color differences | light, naturally permitted                      | naturally permitted             | permitted                           | permitted                           |
| Putty color       | dark brown                                      | dark brown                      | dark brown                          | dark brown                          |

**!** Wood is a natural product - deviations from the listed grading instructions may occur and do not constitute a defect.

# TWIN-PARQUET 18



## CONSTRUCTION

1800-2400 mm (10 % shorter lengths possible)  
 ca. 18 mm | ca. 6 mm top layer (oak)  
 ca. 12 mm plywood support (birch)  
 quality according to factory standards  
 produced analogously according to DIN EN 13489  
 wood moisture ca. 9 % | edges chamfered 2V or 4V | tongue and groove

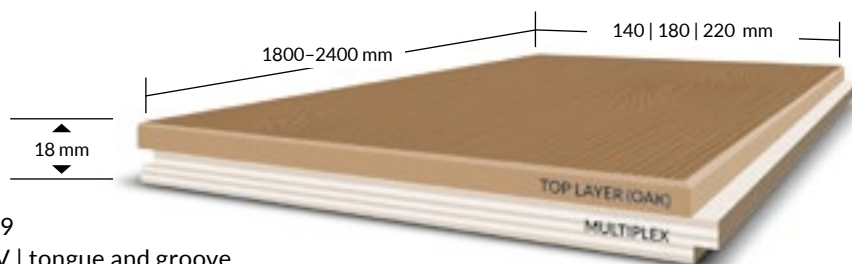

| ARTICLE NO. | PRODUCT DESCRIPTION         | DIMENSIONS | PRICES INCLUDE                                   |
|-------------|-----------------------------|------------|--|
|             |                             |            | LIGHT BRUSHING/END OILED<br>€/m <sup>2</sup> net |
| TP18E140    | Oak Elegant <sup>*/**</sup> | 140 mm     | 119,88   |
| TP18N140    | Oak Natural <sup>*/**</sup> | 140 mm     | 105,88   |
| TP18M140    | Oak Markant <sup>*/**</sup> | 140 mm     | 95,38  |
| TP18R140    | Oak Rustic <sup>*/**</sup>  | 140 mm     | 91,41  |
| TP18E180    | Oak Elegant <sup>*/**</sup> | 180 mm     | 131,55   |
| TP18N180    | Oak Natural <sup>*/**</sup> | 180 mm     | 112,88   |
| TP18M180    | Oak Markant <sup>*/**</sup> | 180 mm     | 99,19  |
| TP18R180    | Oak Rustic <sup>*/**</sup>  | 180 mm     | 95,38  |
| TP18E220    | Oak Elegant <sup>*/**</sup> | 220 mm     | 145,08   |
| TP18N220    | Oak Natural <sup>*/**</sup> | 220 mm     | 126,72   |
| TP18M220    | Oak Markant <sup>*/**</sup> | 220 mm     | 120,60   |
| TP18R220    | Oak Rustic <sup>*/**</sup>  | 220 mm     | 108,37   |

! Due to the different formats, there may be deviations between the ordered and the final product. This slight material overdelivery amounts to max. 3 % and will be invoiced.

\*goods available upon request | \*\*delivery times of 4-6 weeks possible  
 FSC®-Certification: available products on request  
 Orders over 100 sqm also available without chamfer or 2V

## PARQUET OPTIONS IN THE MODULAR PRINCIPLE

### MADE IN GERMANY

All surface treatment and finishing options can be found on page 52 onwards.

### NOTICE FOR SURFACE TREATMENT

\*Staining only in conjunction with oil



|         | ARTICLE NO.    | SURFACE TREATMENT & FINISHING                   |           | €/m <sup>2</sup> net |
|---------|----------------|---|-----------|----------------------|
| SURFACE | ST00           | Sanded  | Discount  | -2,56                |
|         | ST01           | Lightly brushed                                 | Included  | 2,56                 |
|         | ST02           | Medium brushed                                  | Surcharge | +0,88                |
|         | ST03           | Strongly brushed                                | Surcharge | +1,76                |
|         | ST05           | Roughly sawn                                    | Surcharge | +3,53                |
| COLOR   | BXXX/FXXX      | Stained and oiled (end oiled, Rubio Monocoat®)* | Surcharge | +5,82                |
|         | FXXX           | Oiled (end oiled) (Rubio Monocoat®)             | Included  | 5,73                 |
|         | FOXX           | Oiled (Osmo 2K Oil)                             | Surcharge | +2,00                |
|         | FRHR           | Raw wood look (Rubio Monocoat®)                 | Surcharge | +6,87                |
|         | FRHS           | Raw wood look (Saicos)                          | Surcharge | +5,00                |
| FLAC    | Paint (Saicos) | Surcharge                                       | +6,87     |                      |

| GRADING           | ELEGANT   | NATURAL                         | MARKANT                             | RUSTIC                              |
|-------------------|---|---------------------------------|-------------------------------------|-------------------------------------|
| Appearance        | harmonious                                      | calm                            | lively                              | expressive                          |
| Branches          | point and isolated branches up to ca. ø 5-10 mm | healthy branches ca. ø 15-45 mm | branches and edge branches probable | branches and edge branches probable |
| Cracks            | basically free                                  | basically free                  | few permitted                       | permitted                           |
| Hairline cracks   | occasionally permitted                          | occasionally permitted          | occasionally permitted              | permitted                           |
| Sapwood           | basically free                                  | basically free                  | basically free                      | healthy sapwood ca. 20-30%          |
| Color differences | light, naturally permitted                      | naturally permitted             | permitted                           | permitted                           |
| Putty color       | dark brown                                      | dark brown                      | dark brown                          | dark brown                          |

! Wood is a natural product - deviations from the listed grading instructions may occur and do not constitute a defect.

# SURFACE VIEW

## Twin-Parquet

*Raw material without surface treatment*

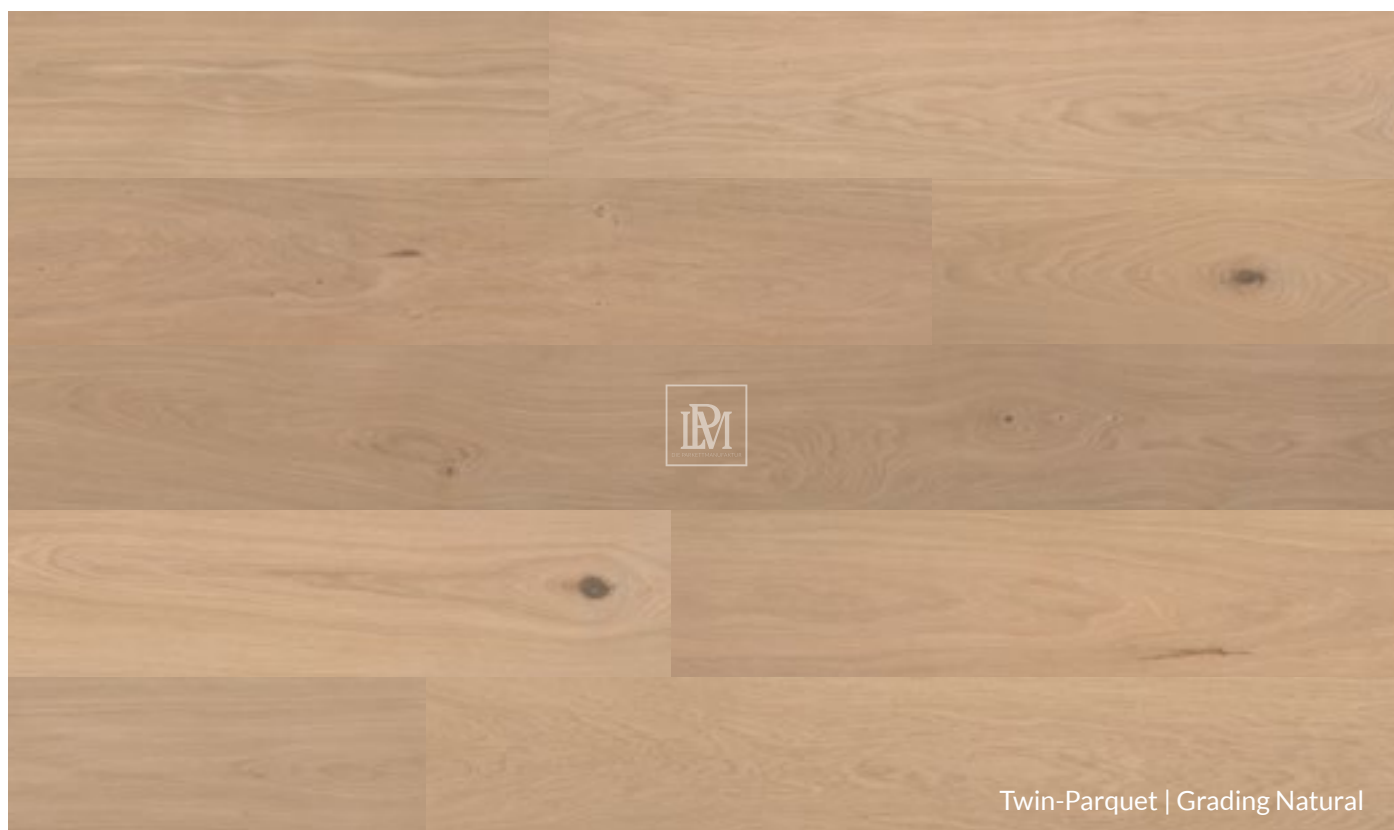
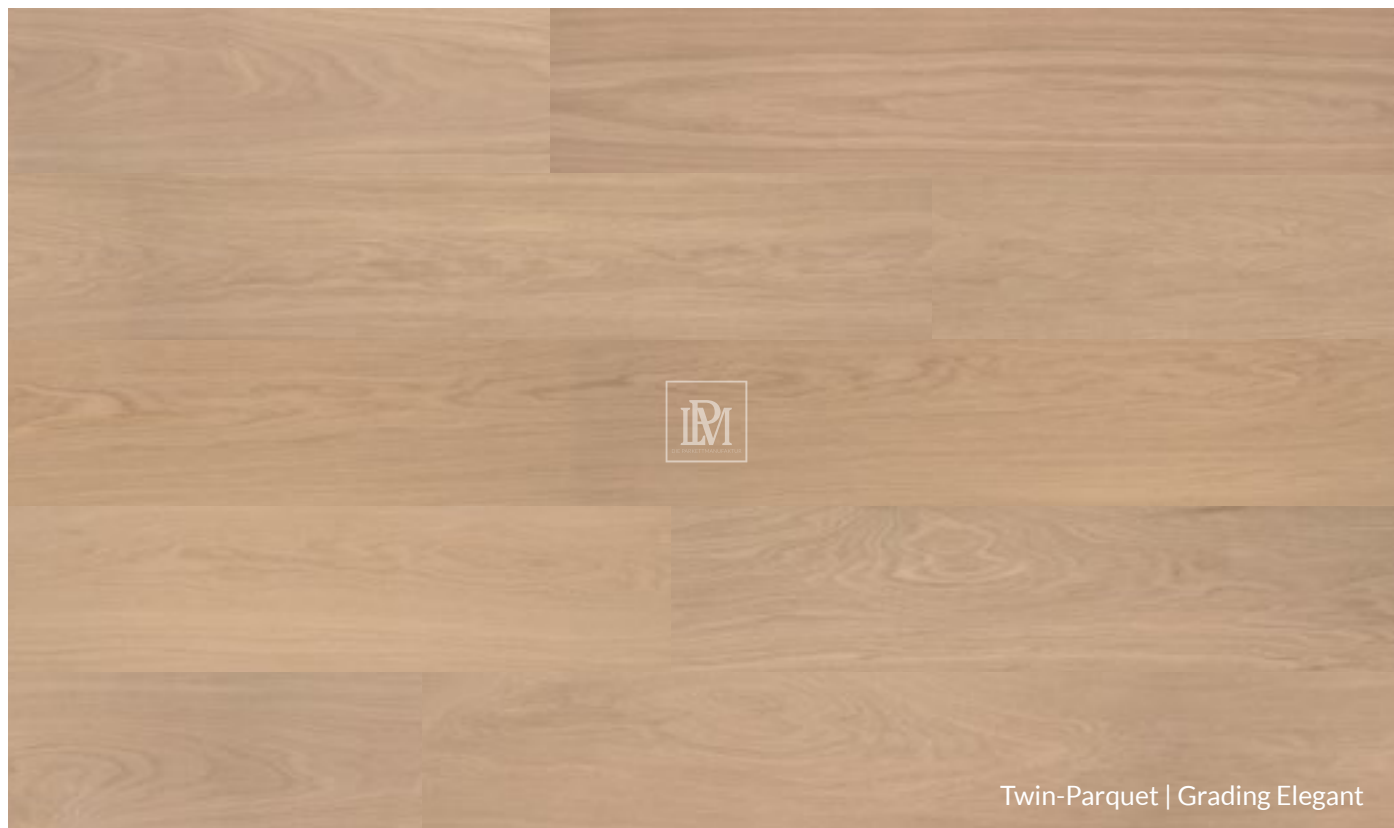

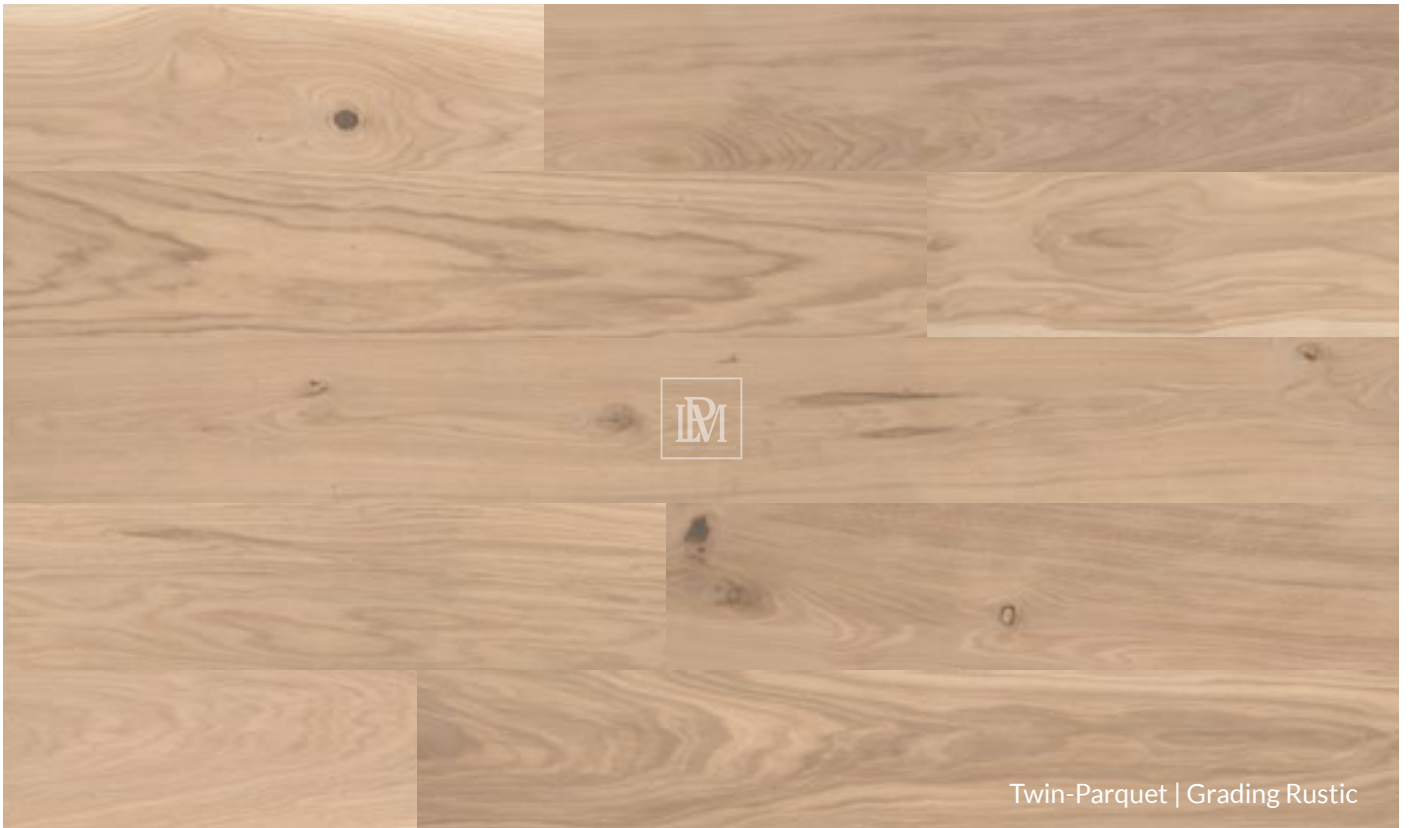
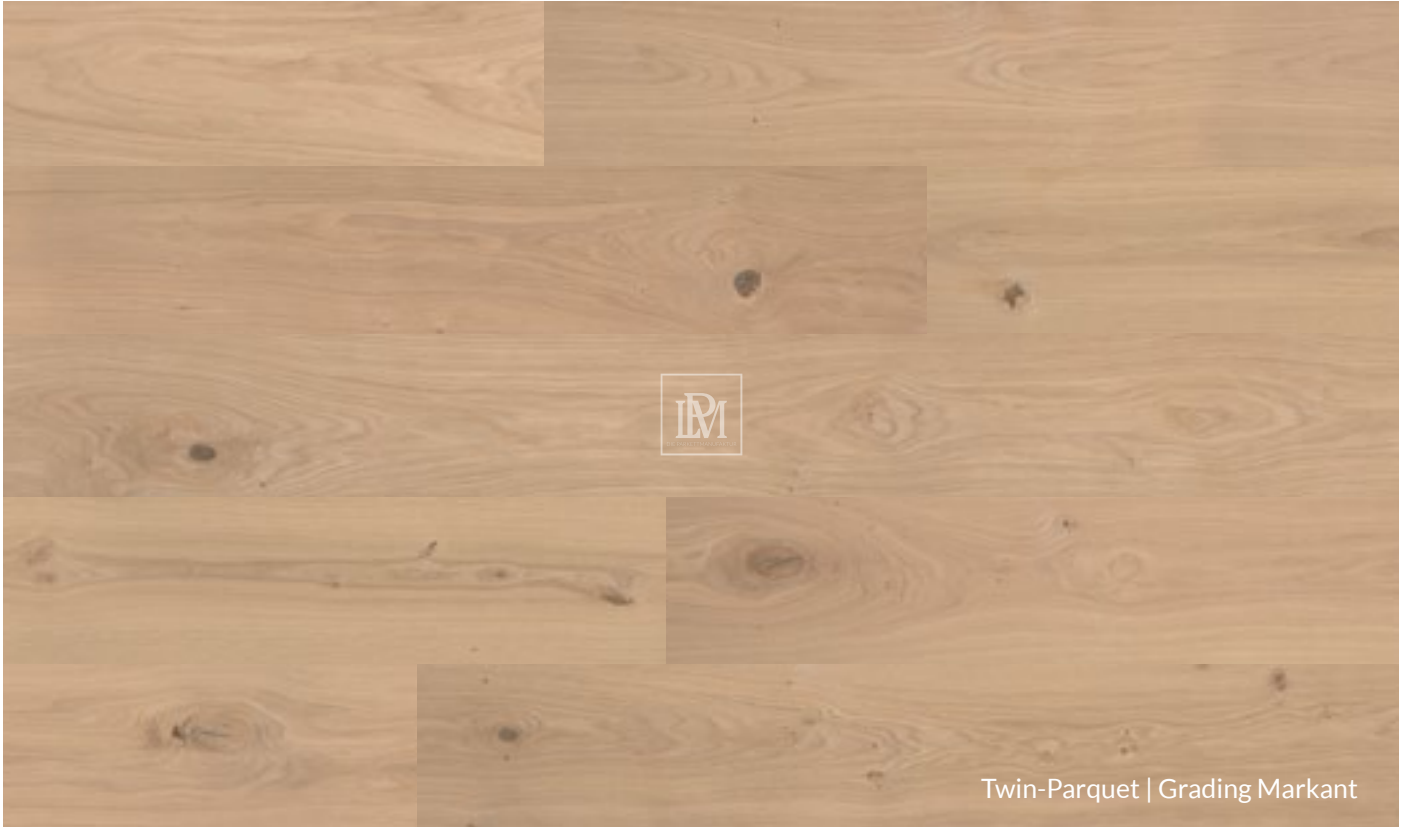



IPM

THE PARQUET MANUFACTURER

## TWIN-STRIP-PARQUET





# TWIN-STRIP-PARQUET

Strip | Herringbone

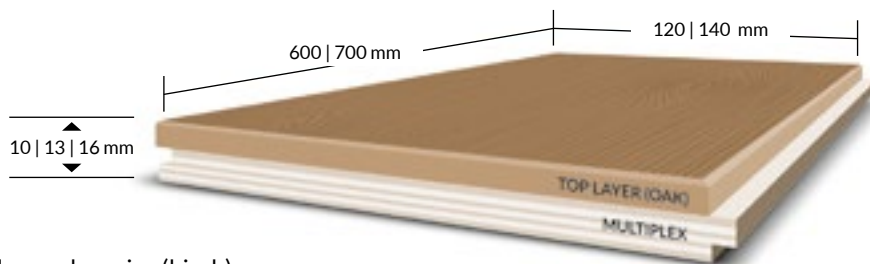

## CONSTRUCTION

ca. 10 mm | ca. 4 mm top layer (oak) | ca. 6 mm plywood carrier (birch)

ca. 13 mm | ca. 4 mm top layer (oak) | ca. 9 mm plywood carrier (birch) – surcharge 4,16 € net

ca. 16 mm | ca. 4 mm top layer (oak) | ca. 12 mm plywood carrier (birch) – surcharge 8,33 € net

produced analogously according to DIN EN 13489 | wood moisture ca. 9 %

chamfered edges 4V / tongue and groove

| ARTICLE NO. | PRODUCT DESCRIPTION                                 | DIMENSIONS        | PRICES INCLUDE<br>LIGHT BRUSHING/END OILED |
|-------------|---|-------------------|--|
|             |   |                   | €/m <sup>2</sup> net                       |
| TPSTAB120EN | Oak Elegant/Natural Strip Parquet / Herringbone 90° | 10 x 120 x 600 mm | 93,95                                      |
| TPSTAB120MR | Oak Markant/Rustic Strip Parquet / Herringbone 90°  | 10 x 120 x 600 mm | 85,55                                      |
| TPSTAB140EN | Oak Elegant/Natural Strip Parquet / Herringbone 90° | 10 x 140 x 700 mm | 93,95                                      |
| TPSTAB140MR | Oak Markant/Rustic Strip Parquet / Herringbone 90°  | 10 x 140 x 700 mm | 85,55                                      |

**!** Herringbone and Hungarian pattern are supplied in the above dimensions with left and right planks.

\*goods available upon request | \*\*delivery times of 4–6 weeks possible

FSC®-Certification: available products on request

Orders over 100 sqm also available with 1 mm chamfer

## PARQUET OPTIONS IN THE MODULAR PRINCIPLE

### MADE IN GERMANY

All surface treatment and finishing options can be found on page 52 onwards.

### NOTICE FOR SURFACE TREATMENT

\*Staining only in conjunction with oil

*Rubio* MONOCOAT

|         | ARTICLE NO. | SURFACE TREATMENT & FINISHING                   |           | €/m <sup>2</sup> net |
|---------|-------------|---|-----------|----------------------|
| SURFACE | ST00        | Sanded  | Discount  | -2,56                |
|         | ST01        | Lightly brushed                                 | Included  | 2,56                 |
|         | ST02        | Medium brushed                                  | Surcharge | +0,88                |
|         | ST03        | Strongly brushed                                | Surcharge | +1,76                |
|         | ST05        | Roughly sawn                                    | Surcharge | +3,53                |
| COLOR   | BXXX/FXXX   | Stained and oiled (end oiled, Rubio Monocoat®)* | Surcharge | +5,82                |
|         | FXXX        | Oiled (end oiled) (Rubio Monocoat®)             | Included  | 5,73                 |
|         | FOXX        | Oiled (Osmo 2K Oil)                             | Surcharge | +2,00                |
|         | FRHR        | Raw wood look (Rubio Monocoat®)                 | Surcharge | +6,87                |
|         | FRHS        | Raw wood look (Saicos)                          | Surcharge | +5,00                |
|         | FLAC        | Paint (Saicos)                                  | Surcharge | +6,87                |

| GRADING           | ELEGANT/NATURAL              | MARKANT/RUSTIC (OBJECT) |
|-------------------|------------------------------|-------------------------|
| Appearance        | harmonious                   | lively                  |
| Branches          | small branches up to ø 10 mm | small branches          |
| Cracks            | basically free               | few permitted           |
| Hairline cracks   | occasionally permitted       | occasionally permitted  |
| Sapwood           | almost free of sapwood       | little sapwood          |
| Color differences | light, naturally permitted   | permitted               |
| Putty color       | dark brown                   | dark brown              |

**!** Wood is a natural product - deviations from the listed grading instructions may occur and do not constitute a defect.

# SURFACE VIEW

## Twin-Strip-Parquet

*Raw material without surface treatment*



Twin-Strip-Parquet | Grading Elegant/Natural | Herringbone



Twin-Strip-Parquet | Grading Markant/Rustic | Herringbone

# LAYING PATTERN

## Twin-Parquet

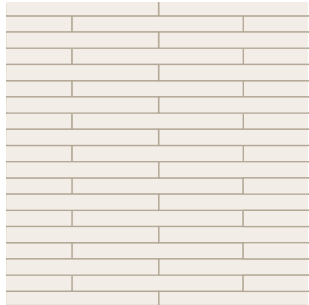

**ENGLISH  
PATTERN**  
1-fold

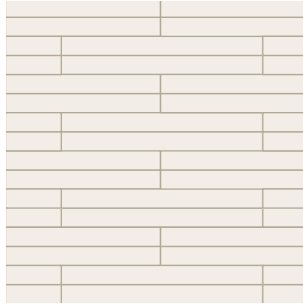

**ENGLISH  
PATTERN**  
2-fold

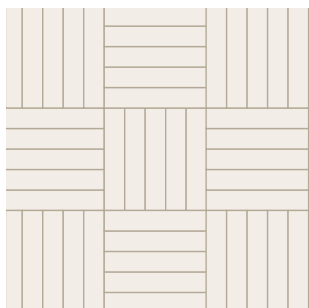

**DICE PATTERN**  
in the formats  
120 x 600 mm  
140 x 700 mm

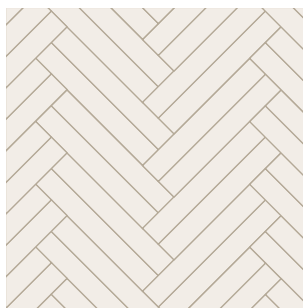

**ANGLE  
PATTERN**  
2-fold

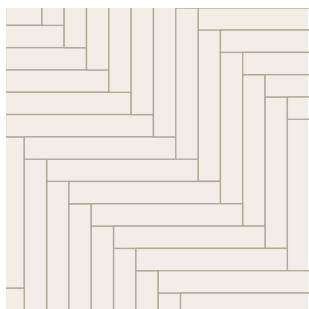

**HERRINGBONE  
PATTERN**  
1-fold

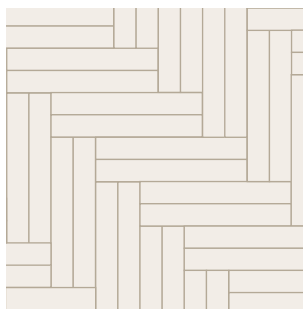

**HERRINGBONE  
PATTERN**  
2-fold



**HERRINGBONE  
PATTERN**  
4-fold

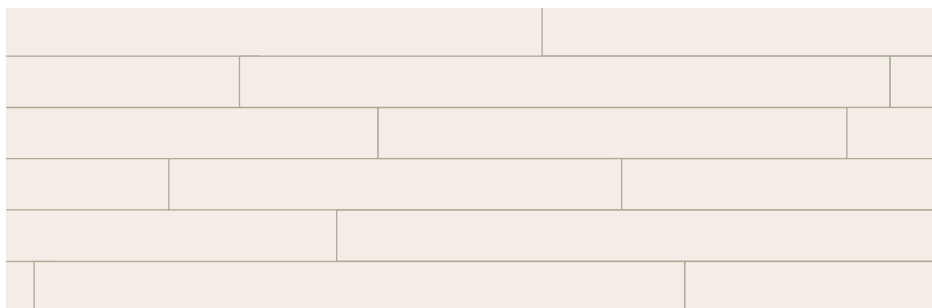

**WILD  
PATTERN**



LPM

THE PARQUET MANUFACTURER

---

SOLID WOOD FLOORBOARDS

---



# SOLID WOOD PLANKS

## CONSTRUCTION

500–2400 mm  
 ca. 20 mm oak  
 quality according to factory standards  
 produced analogously DIN EN 13629  
 wood moisture ca. 9%  
 edges chamfered 4V | tongue and groove all around

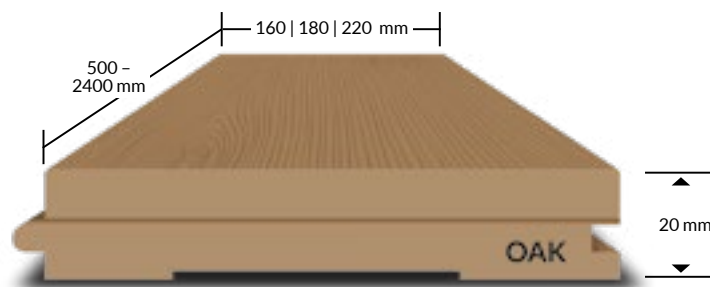

| ARTICLE NO. | PRODUCT DESCRIPTION                 | DIMENSIONS (Falling lengths) | PRICES INCLUDE<br>LIGHT BRUSHING/END OILED |
|-------------|-------------------------------------|------------------------------|--|
|             |                                     |                              | €/m <sup>2</sup> net                       |
| MP20E160    | Oak Solid Wood Floorboards Elegant* | 20 x 160 x 500–2400 mm       | 114,69                                     |
| MP20N160    | Oak Solid Wood Floorboards Natural* | 20 x 160 x 500–2400 mm       | 100,69                                     |
| MP20M160    | Oak Solid Wood Floorboards Markant* | 20 x 160 x 500–2400 mm       | 92,29                                      |
| MP20R160    | Oak Solid Wood Floorboards Rustic*  | 20 x 160 x 500–2400 mm       | 86,69                                      |
| MP20E180    | Oak Solid Wood Floorboards Elegant* | 20 x 180 x 500–2400 mm       | 120,29                                     |
| MP20N180    | Oak Solid Wood Floorboards Natural* | 20 x 180 x 500–2400 mm       | 106,29                                     |
| MP20M180    | Oak Solid Wood Floorboards Markant* | 20 x 180 x 500–2400 mm       | 97,89                                      |
| MP20R180    | Oak Solid Wood Floorboards Rustic*  | 20 x 180 x 500–2400 mm       | 92,29                                      |
| MP20E220    | Oak Solid Wood Floorboards Elegant* | 20 x 220 x 500–2400 mm       | on request                                 |
| MP20N220    | Oak Solid Wood Floorboards Natural* | 20 x 220 x 500–2400 mm       | on request                                 |
| MP20M220    | Oak Solid Wood Floorboards Markant* | 20 x 220 x 500–2400 mm       | 117,49                                     |
| MP20R220    | Oak Solid Wood Floorboards Rustic*  | 20 x 220 x 500–2400 mm       | 95,82                                      |

\*Fixed lengths available on request for an additional charge. Other formats and gradings on request. \*availability of goods on request | \*\*delivery times of 1–6 weeks possible  
 Length distribution: 500–800 mm (20%), 900–1100 mm (20%), 1200–1400 mm (20%), 1500–1700 mm (20%), 1800–2400 mm (20%)  
 FSC®-Certification: available products on request  
 System packaging possible for an additional charge (5 €)  
 Orders over 100 sqm also available without chamfer or 2V

! Due to the different formats, deviations may occur between the ordered and the final produced goods.  
 This slight material overdelivery amounts to a maximum of 3% and will be invoiced.

## PARQUET OPTIONS IN THE MODULAR PRINCIPLE

### MADE IN GERMANY

All surface treatment and finishing options can be found on page 52 onwards.

### NOTICE FOR SURFACE TREATMENT

\*Staining only in conjunction with oil

*Rubio* MONOCOAT

|         | ARTICLE NO. | SURFACE TREATMENT & FINISHING                   |           | €/m <sup>2</sup> net |
|---------|-------------|---|-----------|----------------------|
| SURFACE | ST00        | Sanded  | Discount  | -2,56                |
|         | ST01        | Lightly brushed                                 | Included  | 2,56                 |
|         | ST02        | Medium brushed                                  | Surcharge | +0,88                |
|         | ST03        | Strongly brushed                                | Surcharge | +1,76                |
|         | ST05        | Roughly sawn                                    | Surcharge | +3,53                |
| COLOR   | BXXX/FXXX   | Stained and oiled (end oiled, Rubio Monocoat®)* | Surcharge | +5,82                |
|         | FXXX        | Oiled (end oiled) (Rubio Monocoat®)             | Included  | 5,73                 |
|         | FOXX        | Oiled (Osmo 2K Oil)                             | Surcharge | +2,00                |
|         | FRHR        | Raw wood look (Rubio Monocoat®)                 | Surcharge | +6,87                |
|         | FRHS        | Raw wood look (Saicos)                          | Surcharge | +5,00                |
|         | FLAC        | Paint (Saicos)                                  | Surcharge | +6,87                |

| GRADING           | ELEGANT   | NATURAL                         | MARKANT                            | RUSTIC   |
|-------------------|---|---------------------------------|------------------------------------|--|
| Appearance        | harmonious                                      | calm                            | lively                             | expressive                                       |
| Branches          | point and isolated branches up to ca. ø 5–10 mm | healthy branches ca. ø 15–40 mm | healthy branches ca. ø 40–80 mm    | Branches, edge branches and worm holes available |
| Cracks            | basically free                                  | small ones possible             | small ones possible                | available  |
| Hairline cracks   | occasionally permitted                          | occasionally permitted          | occasionally permitted             | occasionally permitted                           |
| Sapwood           | basically free                                  | basically free                  | healthy sapwood max. 5 % permitted | healthy sapwood ca. 15–20 % permitted            |
| Color differences | light, naturally permitted                      | naturally permitted             | permitted                          | permitted  |
| Putty color       | dark brown                                      | dark brown                      | dark brown                         | dark brown                                       |

! Wood is a natural product - deviations from the listed grading instructions may occur and do not constitute a defect.

# SOLID WOOD FLOORBOARDS

## CONSTRUCTION

500–2400 mm

ca. 15 mm oak

quality according to factory standards | produced analogously DIN EN 13629 | wood moisture ca. 9% edges chamfered 4V | tongue and groove all around

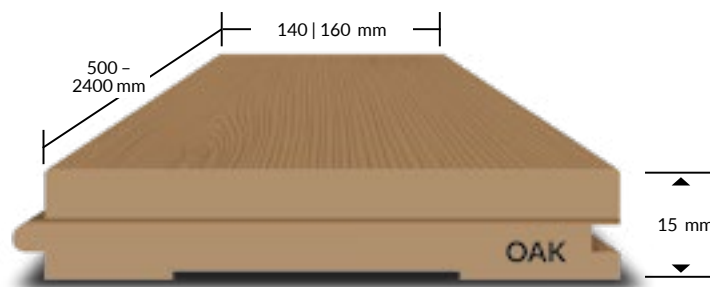

| ARTICLE NO. | PRODUCT DESCRIPTION                 | DIMENSIONS (Falling lengths) | PRICES INCLUDE LIGHT BRUSHING/END OILED |
|-------------|-------------------------------------|------------------------------|---|
|             |                                     |                              | €/m <sup>2</sup> net                    |
| MP15E140    | Oak Solid Wood Floorboards Elegant* | 15 x 140 x 500–2400 mm       | 100,69                                  |
| MP15N140    | Oak Solid Wood Floorboards Natural* | 15 x 140 x 500–2400 mm       | 86,69                                   |
| MP15M140    | Oak Solid Wood Floorboards Markant* | 15 x 140 x 500–2400 mm       | 78,29                                   |
| MP15R140    | Oak Solid Wood Floorboards Rustic*  | 15 x 140 x 500–2400 mm       | 72,69                                   |
| MP15E160    | Oak Solid Wood Floorboards Elegant* | 15 x 160 x 500–2400 mm       | 109,09                                  |
| MP15N160    | Oak Solid Wood Floorboards Natural* | 15 x 160 x 500–2400 mm       | 92,29                                   |
| MP15M160    | Oak Solid Wood Floorboards Markant* | 15 x 160 x 500–2400 mm       | 83,89                                   |
| MP15R160    | Oak Solid Wood Floorboards Rustic*  | 15 x 160 x 500–2400 mm       | 78,29                                   |

\*Fixed lengths available on request for an additional charge.

Other formats and gradings on request.

Length distribution: 500-800 mm (20%), 900-1100 mm (20%), 1200-1400 mm (20%), 1500-1700 mm (20%), 1800-2400 mm (20%)

System packaging possible for an additional charge (5 €)

\*availability of goods on request | \*\*delivery times of 1–6 weeks possible

FSC®-Certification: available products on request

Orders over 100 sqm also available without chamfer or 2V

! Due to the different formats, deviations may occur between the ordered and the final produced goods. This slight material overdelivery amounts to a maximum of 3% and will be invoiced.

## PARQUET OPTIONS IN THE MODULAR PRINCIPLE

### MADE IN GERMANY

All surface treatment and finishing options can be found on page 52 onwards.

### NOTICE FOR SURFACE TREATMENT

\*Staining only in conjunction with oil

Rubio MONOCOAT

|         | ARTICLE NO. | SURFACE TREATMENT & FINISHING                   |           | €/m <sup>2</sup> net |
|---------|-------------|---|-----------|----------------------|
| SURFACE | ST00        | Sanded  | Discount  | -2,56                |
|         | ST01        | Lightly brushed                                 | Included  | 2,56                 |
|         | ST02        | Medium brushed                                  | Surcharge | +0,88                |
|         | ST03        | Strongly brushed                                | Surcharge | +1,76                |
|         | ST05        | Roughly sawn                                    | Surcharge | +3,53                |
| COLOR   | BXXX/FXXX   | Stained and oiled (end oiled, Rubio Monocoat®)* | Surcharge | +5,82                |
|         | FXXX        | Oiled (end oiled) (Rubio Monocoat®)             | Included  | 5,73                 |
|         | FOXX        | Oiled (Osmo 2K Oil)                             | Surcharge | +2,00                |
|         | FRHR        | Raw wood look (Rubio Monocoat®)                 | Surcharge | +6,87                |
|         | FRHS        | Raw wood look (Saicos)                          | Surcharge | +5,00                |
|         | FLAC        | Paint (Saicos)                                  | Surcharge | +6,87                |

| GRADING           | ELEGANT   | NATURAL                         | MARKANT                            | RUSTIC   |
|-------------------|---|---------------------------------|------------------------------------|--|
| Appearance        | harmonious                                      | calm                            | lively                             | expressive                                       |
| Branches          | point and isolated branches up to ca. ø 5–10 mm | healthy branches ca. ø 15–40 mm | healthy branches ca. ø 40–80 mm    | Branches, edge branches and worm holes available |
| Cracks            | basically free                                  | small ones possible             | small ones possible                | available  |
| Hairline cracks   | occasionally permitted                          | occasionally permitted          | occasionally permitted             | occasionally permitted                           |
| Sapwood           | basically free                                  | basically free                  | healthy sapwood max. 5 % permitted | healthy sapwood ca. 15–20 % permitted            |
| Color differences | light, naturally permitted                      | naturally permitted             | permitted                          | permitted  |
| Putty color       | dark brown                                      | dark brown                      | dark brown                         | dark brown                                       |

! Wood is a natural product - deviations from the listed grading instructions may occur and do not constitute a defect.

# SURFACE VIEW

Solid wood floorboards

*Raw material without surface treatment*

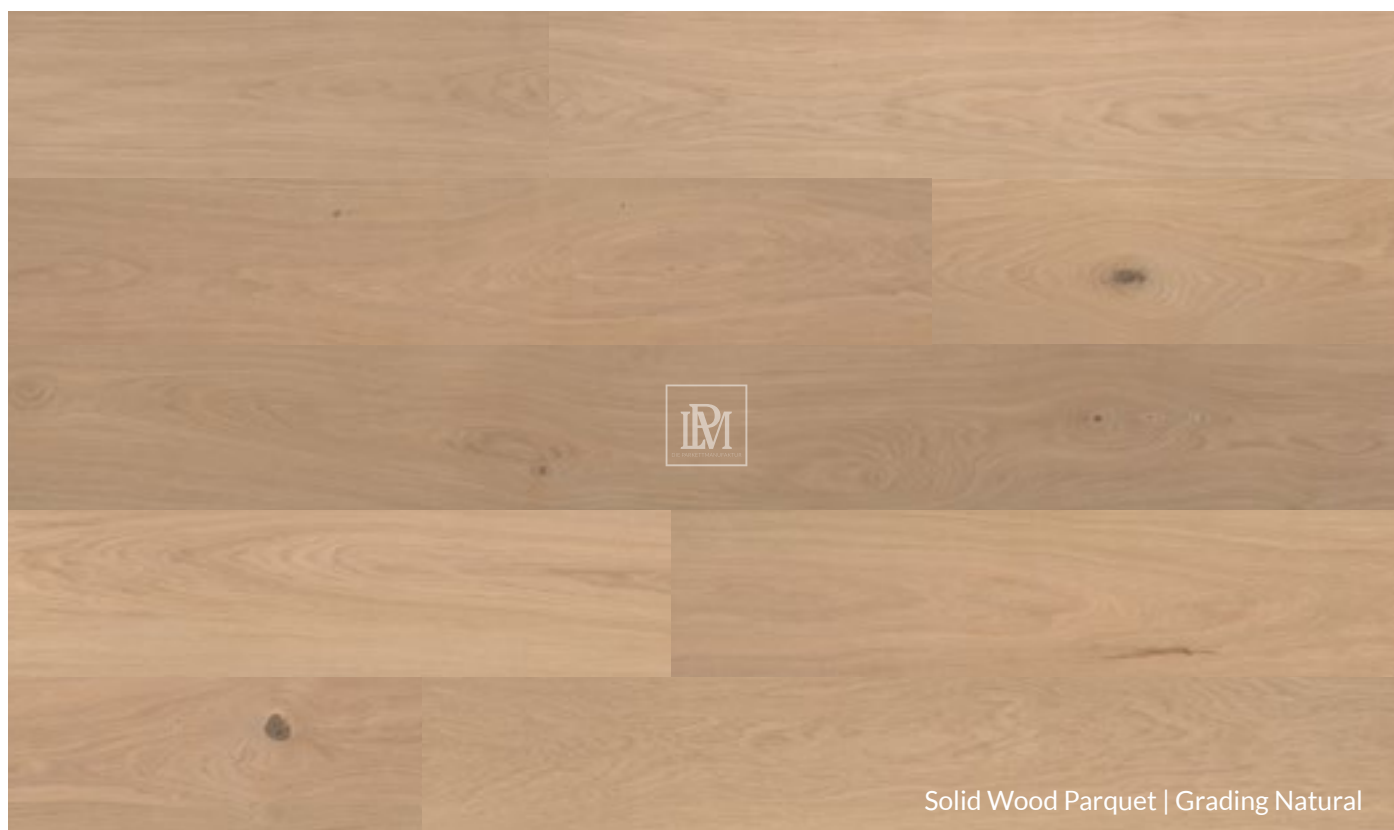
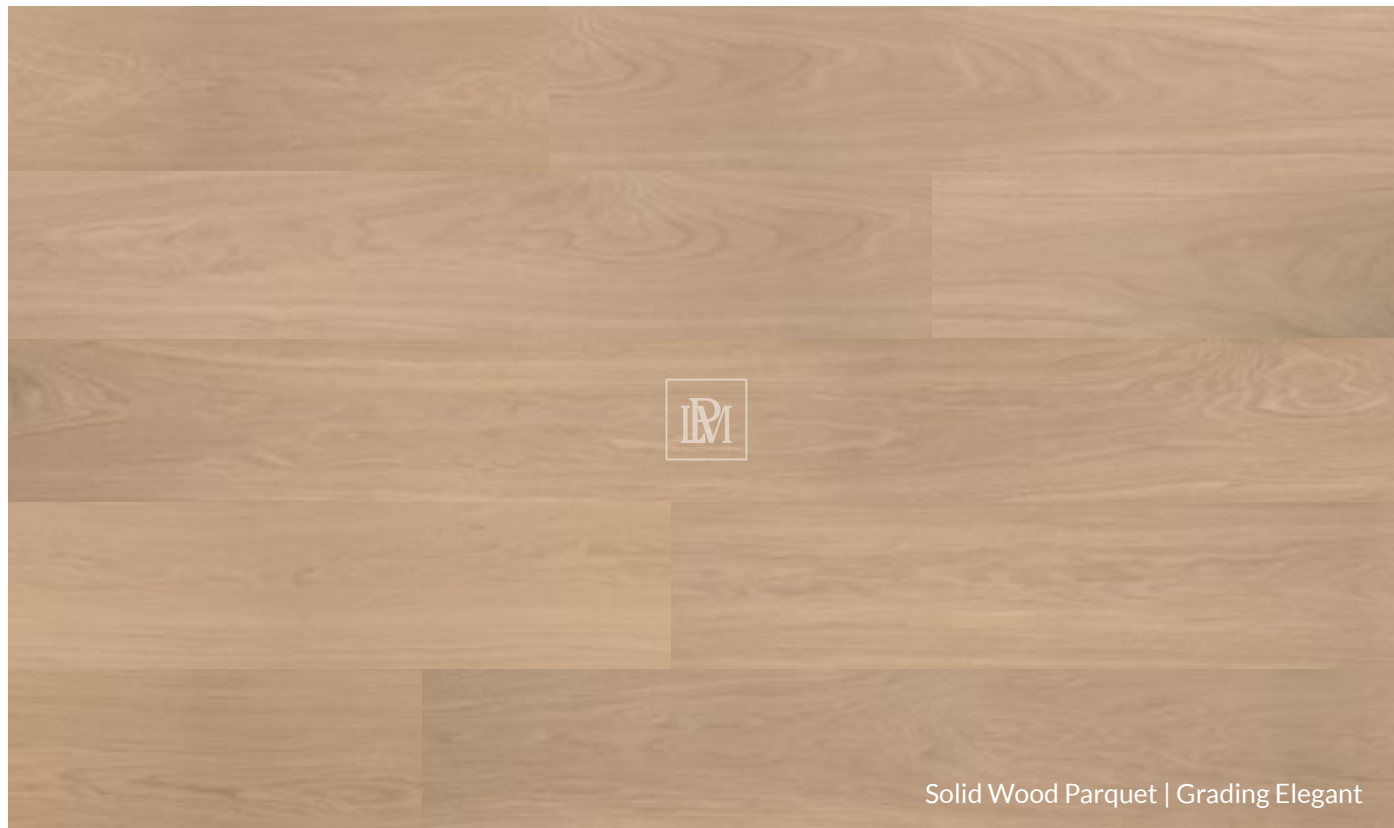

# SURFACE VIEW

Solid wood floorboards

*Raw material without surface treatment*

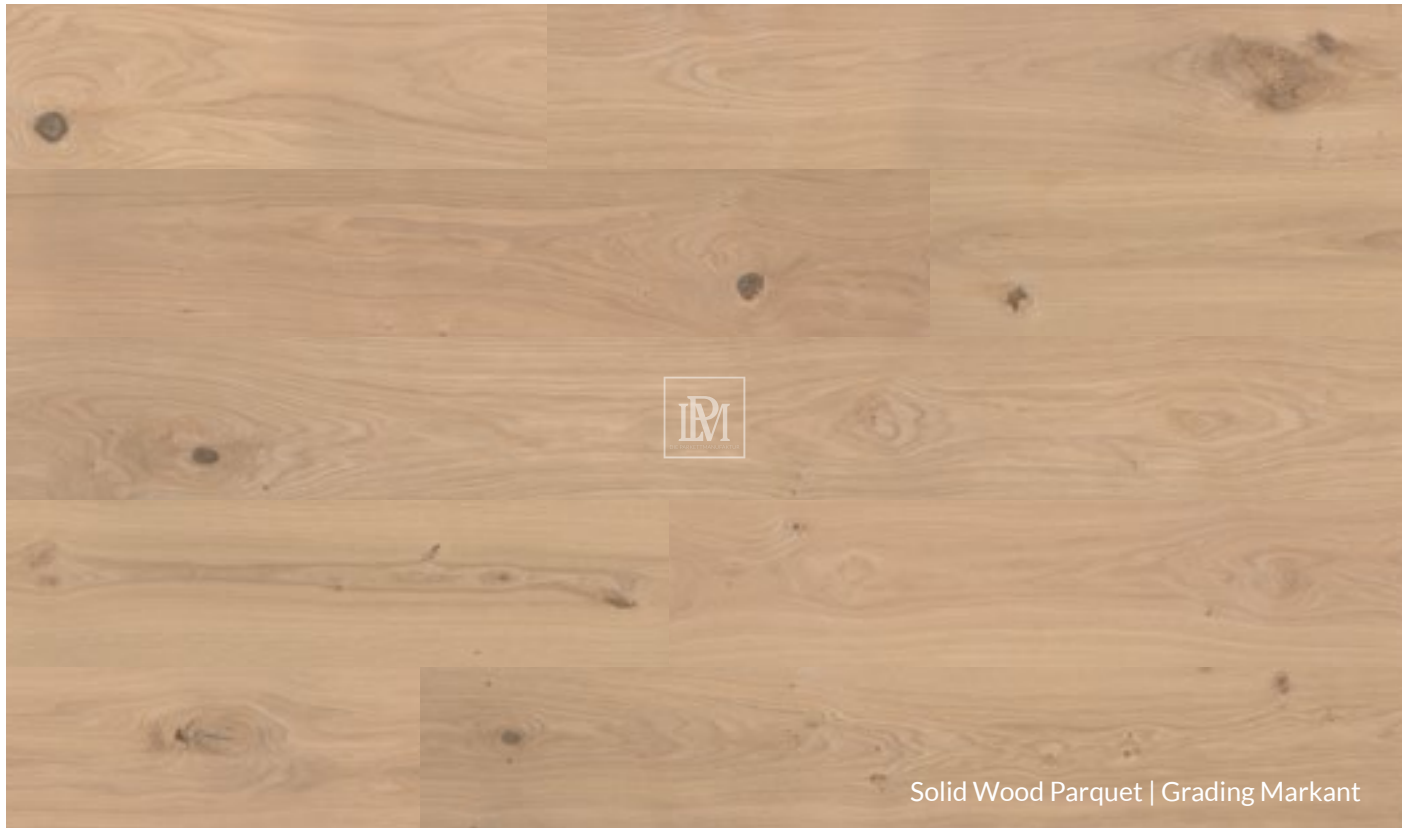

Solid Wood Parquet | Grading Markant



Solid Wood Parquet | Grading Rustic



# SOLID WOOD STRIP-PARQUET

## CONSTRUCTION

700 mm  
 ca. 20 mm oak  
 quality according to factory standards  
 produced analogously DIN EN 13629  
 wood moisture ca. 9%  
 edges chamfered 4V | tongue and groove all around

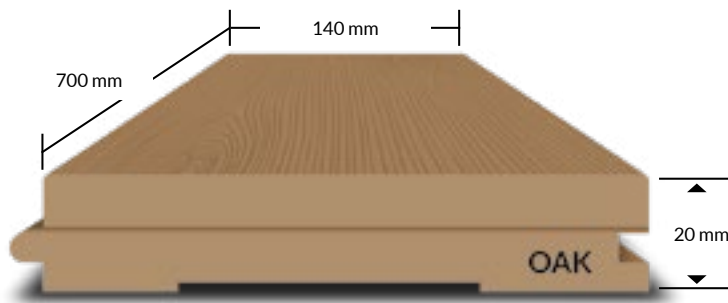

| ARTICLE NO. | PRODUCT DESCRIPTION                          | DIMENSIONS        | PRICES INCLUDE LIGHT BRUSHING/END OILED<br>€/m <sup>2</sup> net |
|-------------|--|-------------------|---|
| MPS20F140EN | Oak Solid Wood Strip-Parquet Elegant/Natural | 20 x 140 x 700 mm | 122,69  |
| MPS20F140MR | Oak Solid Wood Strip-Parquet Markant/Rustic  | 20 x 140 x 700 mm | 107,09  |

**!** Due to the different formats, deviations may occur between the ordered and the final produced goods. This slight material overdelivery amounts to a maximum of 3% and will be invoiced.

\*availability of goods on request | \*\*delivery times of 1-6 weeks possible  
 FSC®-Certification: available products on request  
 Orders over 100 sqm also available with 1 mm chamfer

## PARQUET OPTIONS IN THE MODULAR PRINCIPLE

### MADE IN GERMANY

All surface treatment and finishing options can be found on page 52 onwards.

### NOTICE FOR SURFACE TREATMENT

\*Staining only in conjunction with oil

*Rubio* MONOCOAT

|         | ARTICLE NO. | SURFACE TREATMENT & FINISHING                   |           | €/m <sup>2</sup> net |
|---------|-------------|---|-----------|----------------------|
| SURFACE | ST00        | Sanded  | Discount  | -2,56                |
|         | ST01        | Lightly brushed                                 | Included  | 2,56                 |
|         | ST02        | Medium brushed                                  | Surcharge | +0,88                |
|         | ST03        | Strongly brushed                                | Surcharge | +1,76                |
|         | ST05        | Roughly sawn                                    | Surcharge | +3,53                |
| COLOR   | BXXX/FXXX   | Stained and oiled (end oiled, Rubio Monocoat®)* | Surcharge | +5,82                |
|         | FXXX        | Oiled (end oiled) (Rubio Monocoat®)             | Included  | 5,73                 |
|         | FOXX        | Oiled (Osmo 2K Oil)                             | Surcharge | +2,00                |
|         | FRHR        | Raw wood look (Rubio Monocoat®)                 | Surcharge | +6,87                |
|         | FRHS        | Raw wood look (Saicos)                          | Surcharge | +5,00                |
|         | FLAC        | Paint (Saicos)                                  | Surcharge | +6,87                |

| GRADING           | ELEGANT/NATURAL              | MARKANT/RUSTIC               |
|-------------------|------------------------------|------------------------------|
| Appearance        | harmonious                   | lively                       |
| Branches          | banches up to ca. ø 10–20 mm | banches up to ca. ø 20–40 mm |
| Cracks            | basically free               | few permitted                |
| Hairline cracks   | occasionally permitted       | occasionally permitted       |
| Sapwood           | almost free of sapwood       | little sapwood               |
| Color differences | naturally permitted          | permitted                    |
| Putty color       | dark brown                   | dark brown                   |

**!** Wood is a natural product - deviations from the listed grading instructions may occur and do not constitute a defect.

# SURFACE VIEW

Solid wood strip-parquet

*Raw material without surface treatment*

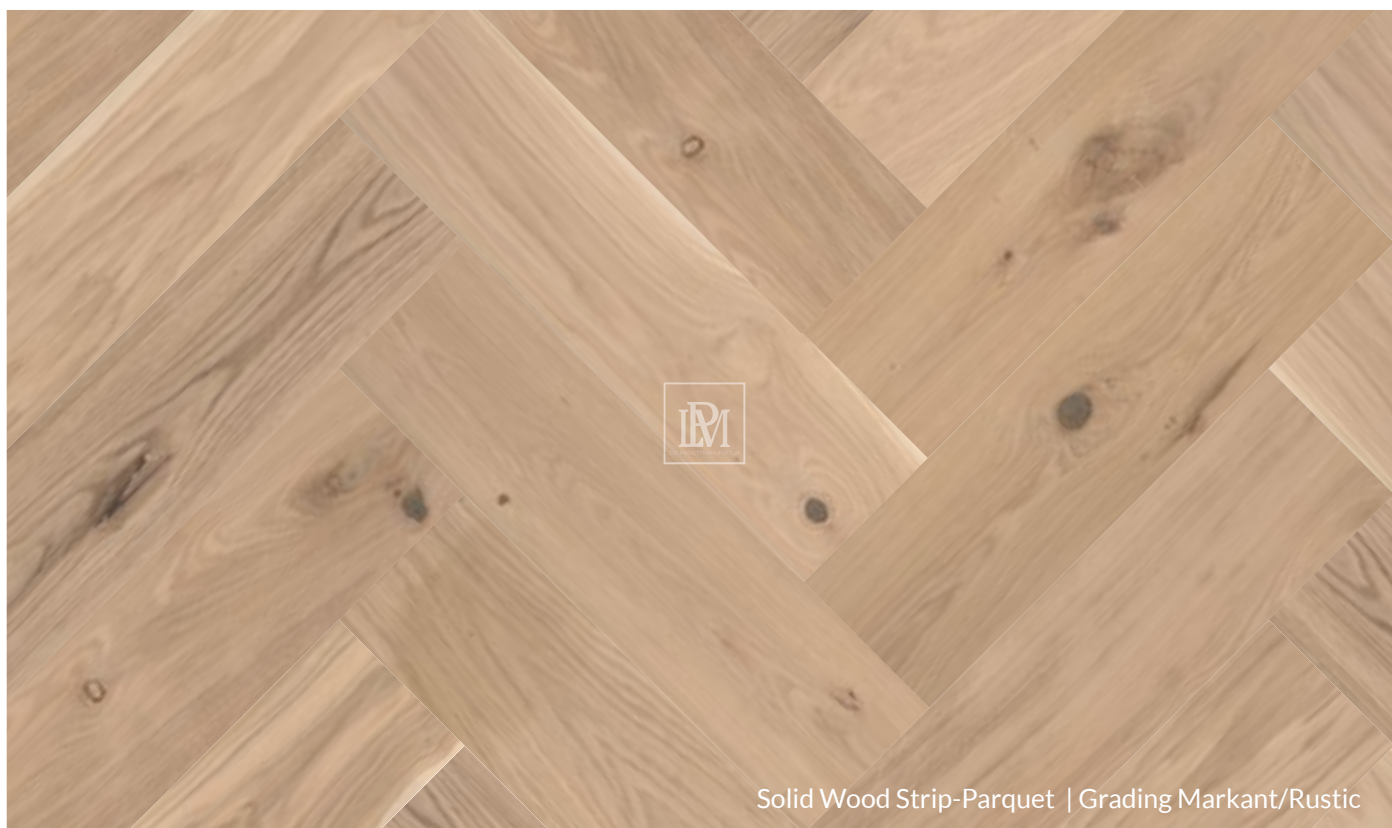



IPM

THE PARQUET MANUFACTURER

3-LAYER  
STRIP-PARQUET

# STRIP-PARQUET TRIO

3-Layer | Herringbone 90°



## CONSTRUCTION

- ca. 11 mm
- ca. 3 mm top layer (european oak)
- middle layer ca. 7 mm (oak)
- counter tension ca. 1 mm (spruce)
- sanded with 120 grit | edges chamfered 4V | tongue and groove
- sharp edges possible with longer delivery times

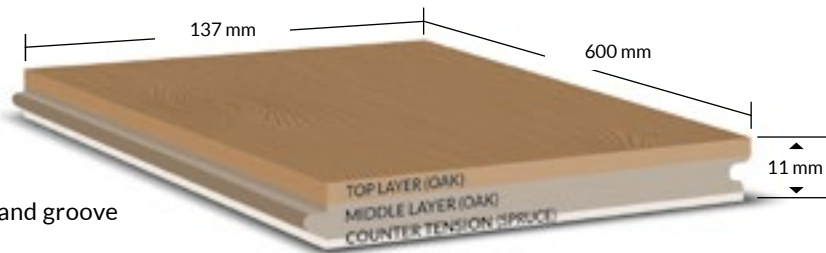

| ARTICLE NO. | PRODUCT DESCRIPTION                         | DIMENSIONS        | PRICES INCLUDE                    |
|-------------|---|-------------------|-----------------------------------|
|             |   |                   | € /m <sup>2</sup> net             |
| SP3F600E    | Oak Elegant Strip Parquet / Herringbone 90° | 11 x 137 x 600 mm | LIGHT BRUSHING/END OILED<br>81,09 |
| SP3F600N    | Oak Natural Strip Parquet / Herringbone 90° | 11 x 137 x 600 mm | 72,69                             |
| SP3F600M    | Oak Markant Strip Parquet / Herringbone 90° | 11 x 137 x 600 mm | 64,29                             |

! Herringbone and Hungarian pattern are supplied in the above dimensions with left and right planks.

\*availability of goods on request | \*\*delivery times of 4-6 weeks possible

## PARQUET OPTIONS IN THE MODULAR PRINCIPLE

### MADE IN GERMANY

All surface treatment and finishing options can be found on page 52 onwards.

### NOTICE FOR SURFACE TREATMENT

\*Staining only in conjunction with oil



|         | ARTICLE NO. | SURFACE TREATMENT & FINISHING                   |           | €/m <sup>2</sup> net |
|---------|-------------|---|-----------|----------------------|
| SURFACE | ST00        | Sanded  | Discount  | -2,56                |
|         | ST01        | Lightly brushed                                 | Included  | 2,56                 |
|         | ST02        | Medium brushed                                  | Surcharge | +0,88                |
|         | ST03        | Strongly brushed                                | Surcharge | +1,76                |
|         | ST05        | Roughly sawn                                    | Surcharge | +3,53                |
| COLOR   | BXXX/FXXX   | Stained and oiled (end oiled, Rubio Monocoat®)* | Surcharge | +5,82                |
|         | FXXX        | Oiled (end oiled) (Rubio Monocoat®)             | Included  | 5,73                 |
|         | FOXX        | Oiled (Osmo 2K Oil)                             | Surcharge | +2,00                |
|         | FRHR        | Raw wood look (Rubio Monocoat®)                 | Surcharge | +6,87                |
|         | FRHS        | Raw wood look (Saicos)                          | Surcharge | +5,00                |
|         | FLAC        | Paint (Saicos)                                  | Surcharge | +6,87                |

| GRADING           | ELEGANT                                      | NATURAL                               | MARKANT                               |
|-------------------|--|---------------------------------------|---------------------------------------|
| Appearance        | harmonious                                   | calm                                  | lively                                |
| Branches          | point and isolated branches up to ca. ø 5 mm | healthy branches up to ca. ø 15-20 mm | healthy branches up to ca. ø 15-30 mm |
| Cracks            | basically free                               | few possible                          | permitted                             |
| Hairline cracks   | occasionally permitted                       | occasionally permitted                | permitted                             |
| Sapwood           | basically free                               | basically free                        | sapwood possible up to 11 %           |
| Color differences | light, naturally permitted                   | naturally permitted                   | permitted                             |
| Putty color       | dark brown                                   | dark brown                            | dark brown                            |

! Wood is a natural product - deviations from the listed grading instructions may occur and do not constitute a defect.

# SURFACE VIEW

## 3-Layer-Strip-Parquet

*Raw material without surface treatment*



# LAYING PATTERN

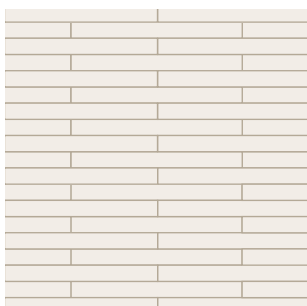

**ENGLISH PATTERN**  
1-fold

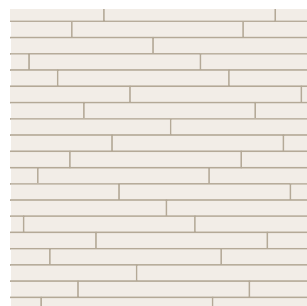

**WILD PATTERN**  
1-fold

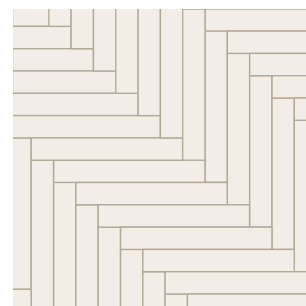

**HERRINGBONE PATTERN**  
1-fold

# STRIP-PARQUET TRIO

3-Layer | Herringbone 90° (Object)



## CONSTRUCTION

- ca. 11 mm
- ca. 3 mm top layer (european oak)
- middle layer ca. 7 mm (oak)
- counter tension ca. 1 mm (spruce)
- sanded with 120 grit
- edges chamfered 4V (micro bevel) | tongue and groove

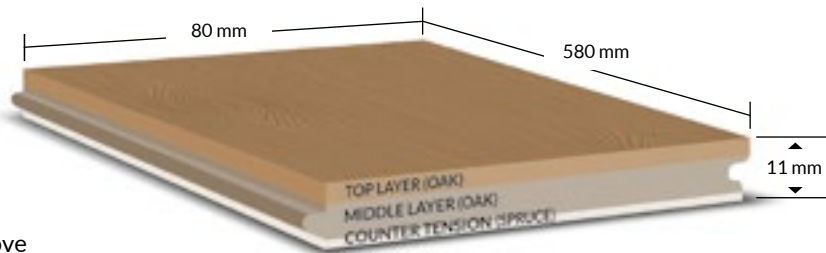

| ARTICLE NO. | PRODUCT DESCRIPTION                                 | DIMENSIONS       | PRICES INCLUDE<br>LIGHT BRUSHING/END OILED<br>€/m <sup>2</sup> net |
|-------------|---|------------------|--|
| SP30580R    | Oak Rustic (Object) Strip Parquet / Herringbone 90° | 11 x 80 x 580 mm | 72,69  |

! Herringbone and Hungarian pattern are supplied in the above dimensions with left and right planks.

\*availability of goods on request | \*\*delivery times of 4-6 weeks possible

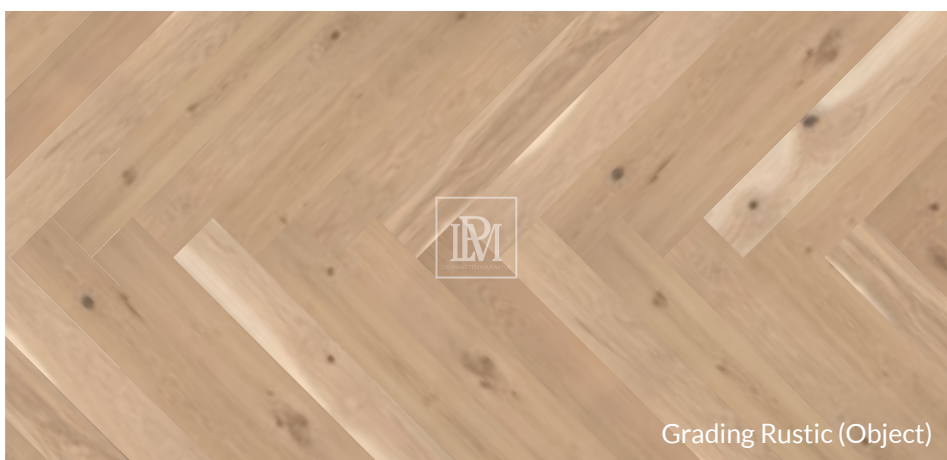

## PARQUET OPTIONS IN THE MODULAR PRINCIPLE

### MADE IN GERMANY

All surface treatment and finishing options can be found on page 52 onwards.

### NOTICE FOR SURFACE TREATMENT

\*Staining only in conjunction with oil



|         | ARTICLE NO. | SURFACE TREATMENT & FINISHING                   |           | €/m <sup>2</sup> net |
|---------|-------------|---|-----------|----------------------|
| SURFACE | ST00        | Sanded  | Discount  | -2,56                |
|         | ST01        | Lightly brushed                                 | Included  | 2,56                 |
|         | ST02        | Medium brushed                                  | Surcharge | +0,88                |
|         | ST03        | Strongly brushed                                | Surcharge | +1,76                |
|         | ST05        | Roughly sawn                                    | Surcharge | +3,53                |
| COLOR   | BXXX/FXXX   | Stained and oiled (end oiled, Rubio Monocoat®)* | Surcharge | +5,82                |
|         | FXXX        | Oiled (end oiled) (Rubio Monocoat®)             | Included  | 5,73                 |
|         | FOXX        | Oiled (Osmo 2K Oil)                             | Surcharge | +2,00                |
|         | FRHR        | Raw wood look (Rubio Monocoat®)                 | Surcharge | +6,87                |
|         | FRHS        | Raw wood look (Saicos)                          | Surcharge | +5,00                |
|         | FLAC        | Paint (Saicos)                                  | Surcharge | +6,87                |

| GRADING           | RUSTIC (OBJECT)                     |
|-------------------|-------------------------------------|
| Appearance        | expressive                          |
| Branches          | branches and edge branches possible |
| Cracks            | permitted                           |
| Hairline cracks   | permitted                           |
| Sapwood           | healthy sapwood stains, ca. 20-30 % |
| Color differences | permitted                           |
| Putty color       | dark brown                          |

! Wood is a natural product - deviations from the listed grading instructions may occur and do not constitute a defect.



# STRIP-PARQUET TRIO

3-Layer | French Herringbone | Chevron

## CONSTRUCTION

- ca. 11 mm
- ca. 3 mm top layer (european oak)
- middle layer ca. 7 mm (oak)
- counter tension ca. 1 mm (spruce)
- sanded with 120 grit
- chamfered all around | tongue and groove

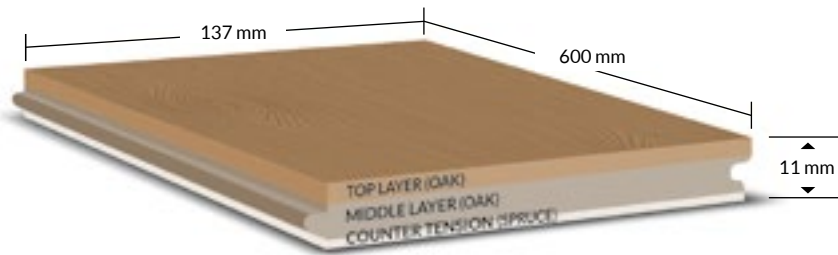

| ARTICLE NO. | PRODUCT DESCRIPTION    | DIMENSIONS        | PRICES INCLUDE                                   |
|-------------|------------------------|-------------------|--|
|             |                        |                   | LIGHT BRUSHING/END OILED<br>€/m <sup>2</sup> net |
| SPFF600E    | Oak Elegant French 45° | 11 x 137 x 600 mm | 106,29   |
| SPFF600N    | Oak Natural French 45° | 11 x 137 x 600 mm | 89,49  |
| SPFF600M    | Oak Markant French 45° | 11 x 137 x 600 mm | 78,29  |

! Herringbone and Hungarian bandages are supplied in the above dimensions with left and right strip.

\*availability of goods on request | \*\*delivery times of 4-6 weeks possible

## PARQUET OPTIONS IN THE MODULAR PRINCIPLE

### MADE IN GERMANY

All surface treatment and finishing options can be found on page 52 onwards.

### NOTICE FOR SURFACE TREATMENT

°Staining only in conjunction with oil



|         | ARTICLE NO.    | SURFACE TREATMENT & FINISHING                   |           | €/m <sup>2</sup> net |
|---------|----------------|---|-----------|----------------------|
| SURFACE | ST00           | Sanded  | Discount  | -2,56                |
|         | ST01           | Lightly brushed                                 | Included  | 2,56                 |
|         | ST02           | Medium brushed                                  | Surcharge | +0,88                |
|         | ST03           | Strongly brushed                                | Surcharge | +1,76                |
|         | ST05           | Roughly sawn                                    | Surcharge | +3,53                |
| COLOR   | BXXX/FXXX      | Stained and oiled (end oiled, Rubio Monocoat®)° | Surcharge | +5,82                |
|         | FXXX           | Oiled (end oiled) (Rubio Monocoat®)             | Included  | 5,73                 |
|         | FOXX           | Oiled (Osno 2K Oil)                             | Surcharge | +2,00                |
|         | FRHR           | Raw wood look (Rubio Monocoat®)                 | Surcharge | +6,87                |
|         | FRHS           | Raw wood look (Saicos)                          | Surcharge | +5,00                |
| FLAC    | Paint (Saicos) | Surcharge                                       | +6,87     |                      |

| GRADING           | ELEGANT   | NATURAL                         | MARKANT                         |
|-------------------|---|---------------------------------|---------------------------------|
| Appearance        | harmonious  | calm                            | lively                          |
| Branches          | point branches and occasional branches up to ca. ø 5 mm | healthy branches ca. ø 15-20 mm | healthy branches ca. ø 15-30 mm |
| Cracks            | basically free  | small ones possible             | permitted                       |
| Hairline cracks   | occasionally permitted                                  | occasionally permitted          | permitted                       |
| Sapwood           | basically free  | basically free                  | sapwood possible up to 11 %     |
| Color differences | light, naturally permitted                              | naturally permitted             | permitted                       |
| Putty color       | dark brown  | dark brown                      | dark brown                      |

! Wood is a natural product - deviations from the listed grading instructions may occur and do not constitute a defect.

# SURFACE VIEW

French Herringbone | Chevron

*Raw material without surface treatment*



# LAYING PATTERN

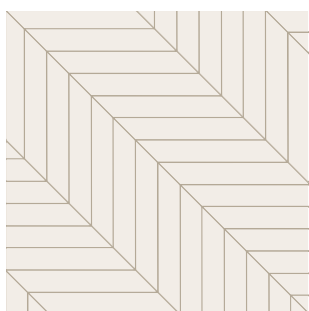

**FRENCH HERRINGBONE  
CHEVRON**





**IPM**

THE PARQUET MANUFACTURER

**3-LAYER-PARQUET**

# COUNTRY HOUSE FLOOR-BOARDS 3-LAYER 5G-C 190



## CONSTRUCTION

length 1800 | 2000 | 2190 | 2200 | 2300 | 2390 mm  
(no jointed planks)  
ca. 14 mm | top layer (oak) ca. 3 mm (+/-10%)  
middle layer ca. 9 mm | counter tension ca. 2 mm (pine)  
wood moisture 8 % (+/-1%)  
4-sided micro bevel | click connection Välinge 5G-C

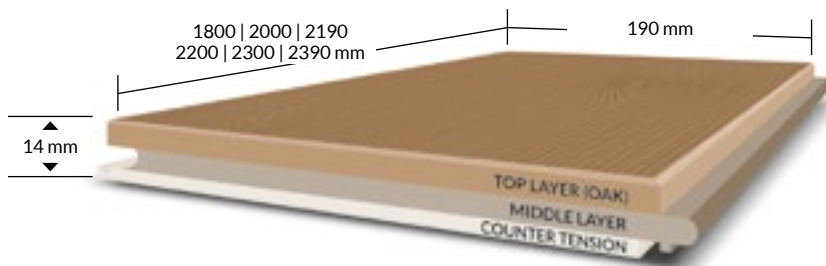

| ARTICLE NO. | PRODUCT DESCRIPTION | DIMENSIONS  | PRICES INCLUDE LIGHT BRUSHING/END OILED<br>€/m <sup>2</sup> net |
|-------------|---------------------|---|---|
| DSP5G14E190 | Oak Elegant*        | 14/3 x 190 x 1800 / 2000 / 2190 / 2200 / 2300 / 2390 mm | 106,29  |
| DSP5G14N190 | Oak Natural*        | 14/3 x 190 x 1800 / 2000 / 2190 / 2200 / 2300 / 2390 mm | 92,29   |
| DSP5G14M190 | Oak Markant*        | 14/3 x 190 x 1800 / 2000 / 2190 / 2200 / 2300 / 2390 mm | 76,89   |
| DSP5G14R190 | Oak Rustic*         | 14/3 x 190 x 1800 / 2000 / 2190 / 2200 / 2300 / 2390 mm | 68,49   |

| PACKAGES   | 8 Planks | PU 190 x 1800 = 2,73 m <sup>2</sup> | Palette: 40 Packages = 109,20 m <sup>2</sup> |
|--|----------|-------------------------------------|--|
| <b>EXTRA CHARGE:</b><br>Top layer 4 mm 2,00 €/m <sup>2</sup> | 8 Planks | PU 190 x 2000 = 3,04 m <sup>2</sup> | Palette: 36 Packages = 109,44 m <sup>2</sup> |
|  | 8 Planks | PU 190 x 2190 = 3,33 m <sup>2</sup> | Palette: 32 Packages = 106,56 m <sup>2</sup> |
|  | 8 Planks | PU 190 x 2200 = 3,34 m <sup>2</sup> | Palette: 32 Packages = 106,88 m <sup>2</sup> |
|  | 8 Planks | PU 190 x 2300 = 3,49 m <sup>2</sup> | Palette: 32 Packages = 111,68 m <sup>2</sup> |
|  | 8 Planks | PU 190 x 2390 = 3,63 m <sup>2</sup> | Palette: 32 Packages = 116,16 m <sup>2</sup> |

Payment terms according to agreement, delivery and production times depending on order quantity (from 400 m<sup>2</sup> ca. 6-8 weeks)

\*delivery subject to availability | no length guarantee

## PARQUET OPTIONS IN THE MODULAR PRINCIPLE

### MADE IN GERMANY

All surface treatment and finishing options can be found on page 52 onwards.

### NOTICE FOR SURFACE TREATMENT

\*Staining only in conjunction with oil



|         | ARTICLE NO. | SURFACE TREATMENT & FINISHING                   | €/m <sup>2</sup> net |
|---------|-------------|---|----------------------|
| SURFACE | ST00        | Sanded  | Discount -2,56       |
|         | ST01        | Lightly brushed                                 | Included 2,56        |
|         | ST02        | Medium brushed                                  | Surcharge +0,88      |
|         | ST03        | Strongly brushed                                | Surcharge +1,76      |
|         | ST05        | Roughly sawn                                    | Surcharge +3,53      |
| COLOR   | BXXX/FXXX   | Stained and oiled (end oiled, Rubio Monocoat®)* | Surcharge +5,82      |
|         | FXXX        | Oiled (end oiled) (Rubio Monocoat®)             | Included 5,73        |
|         | FOXX        | Oiled (Osmo 2K Oil)                             | Surcharge +2,00      |
|         | FRHR        | Raw wood look (Rubio Monocoat®)                 | Surcharge +6,87      |
|         | FRHS        | Raw wood look (Saicos)                          | Surcharge +5,00      |
|         | FLAC        | Paint (Saicos)                                  | Surcharge +6,87      |

| GRADING           | ELEGANT  | NATURAL                         | MARKANT                                   | RUSTIC                               |
|-------------------|--|---------------------------------|---|--------------------------------------|
| Appearance        | harmonious   | calm                            | lively                                    | expressive                           |
| Branches          | point branches and occasional branches up to ca. ø 5-10 mm | healthy branches ca. ø 15-50 mm | branches and edge branches ca. ø 50-70 mm | branches and edge branches available |
| Cracks            | basically free   | small ones possible             | permitted                                 | permitted                            |
| Hairline cracks   | occasionally permitted                                     | occasionally permitted          | permitted                                 | permitted                            |
| Sapwood           | basically free   | basically free                  | sapwood possible up to 11 %               | healthy sapwood stains, ca. 20-30 %  |
| Color differences | light, naturally permitted                                 | naturally permitted             | permitted                                 | permitted                            |
| Putty color       | dark brown   | dark brown                      | dark brown                                | dark brown                           |

! Wood is a natural product - deviations from the listed grading instructions may occur and do not constitute a defect.

# COUNTRY HOUSE FLOOR-BOARDS 3-LAYER 5G-C 220



## CONSTRUCTION

length 1800 | 2000 | 2190 | 2200 | 2300 | 2390 mm  
(no jointed planks)  
ca. 14 mm | top layer (oak) ca. 3 mm (+/-10%)  
middle layer ca. 9 mm | counter tension ca. 2 mm (pine)  
wood moisture 8 % (+/-1 %)  
4-sided micro bevel | click connection Välinge 5G-C

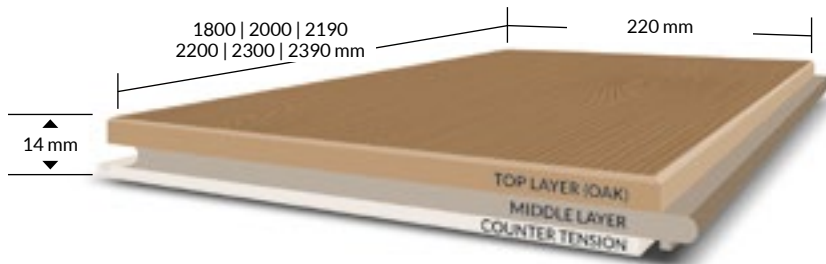

| ARTICLE NO. | PRODUCT DESCRIPTION | DIMENSIONS  | PRICES INCLUDE<br>LIGHT BRUSHING/END OILED |
|-------------|---------------------|---|--|
|             |                     |   | €/m <sup>2</sup> net                       |
| DSP5G14E220 | Oak Elegant*        | 14/3 x 220 x 1800 / 2000 / 2190 / 2200 / 2300 / 2390 mm | 114,69                                     |
| DSP5G14N220 | Oak Natural*        | 14/3 x 220 x 1800 / 2000 / 2190 / 2200 / 2300 / 2390 mm | 100,69                                     |
| DSP5G14M220 | Oak Markant*        | 14/3 x 220 x 1800 / 2000 / 2190 / 2200 / 2300 / 2390 mm | 81,09                                      |
| DSP5G14R220 | Oak Rustic*         | 14/3 x 220 x 1800 / 2000 / 2190 / 2200 / 2300 / 2390 mm | 72,69                                      |

| PACKAGES  | 8 Planks | PU 220 x 1800 = 3,16 m <sup>2</sup> | Palette: 36 Packages = 113,76 m <sup>2</sup> |
|---|----------|-------------------------------------|--|
| <b>EXTRA CHARGE:</b><br>Top layer 4 mm 2,00 €/m <sup>2</sup><br><br>Payment terms according to agreement, delivery and production times depending on order quantity (from 400 m <sup>2</sup> ca. 6-8 weeks) | 8 Planks | PU 220 x 2000 = 3,52 m <sup>2</sup> | Palette: 32 Packages = 112,64 m <sup>2</sup> |
|   | 6 Planks | PU 220 x 2190 = 2,89 m <sup>2</sup> | Palette: 36 Packages = 104,04 m <sup>2</sup> |
|   | 6 Planks | PU 220 x 2200 = 2,90 m <sup>2</sup> | Palette: 36 Packages = 104,40 m <sup>2</sup> |
|   | 6 Planks | PU 220 x 2300 = 3,03 m <sup>2</sup> | Palette: 36 Packages = 109,08 m <sup>2</sup> |
|   | 6 Planks | PU 220 x 2390 = 3,15 m <sup>2</sup> | Palette: 32 Packages = 100,80 m <sup>2</sup> |

\*delivery subject to availability | no length guarantee

## PARQUET OPTIONS IN THE MODULAR PRINCIPLE

### MADE IN GERMANY

All surface treatment and finishing options can be found on page 52 onwards.

### NOTICE FOR SURFACE TREATMENT

\*Staining only in conjunction with oil



|         | ARTICLE NO. | SURFACE TREATMENT & FINISHING                   |           | €/m <sup>2</sup> net |
|---------|-------------|---|-----------|----------------------|
| SURFACE | ST00        | Sanded  | Discount  | -2,56                |
|         | ST01        | Lightly brushed                                 | Included  | 2,56                 |
|         | ST02        | Medium brushed                                  | Surcharge | +0,88                |
|         | ST03        | Strongly brushed                                | Surcharge | +1,76                |
|         | ST05        | Roughly sawn                                    | Surcharge | +3,53                |
| COLOR   | BXXX/FXXX   | Stained and oiled (end oiled, Rubio Monocoat®)* | Surcharge | +5,82                |
|         | FXXX        | Oiled (end oiled) (Rubio Monocoat®)             | Included  | 5,73                 |
|         | FOXX        | Oiled (Osmo 2K Oil)                             | Surcharge | +2,00                |
|         | FRHR        | Raw wood look (Rubio Monocoat®)                 | Surcharge | +6,87                |
|         | FRHS        | Raw wood look (Saicos)                          | Surcharge | +5,00                |
|         | FLAC        | Paint (Saicos)                                  | Surcharge | +6,87                |

| GRADING           | ELEGANT  | NATURAL                         | MARKANT                                   | RUSTIC                               |
|-------------------|--|---------------------------------|---|--------------------------------------|
| Appearance        | harmonious   | calm                            | lively                                    | expressive                           |
| Branches          | point branches and occasional branches up to ca. ø 5-10 mm | healthy branches ca. ø 15-50 mm | branches and edge branches ca. ø 50-70 mm | branches and edge branches available |
| Cracks            | basically free   | small ones possible             | permitted                                 | permitted                            |
| Hairline cracks   | occasionally permitted                                     | occasionally permitted          | permitted                                 | permitted                            |
| Sapwood           | basically free   | basically free                  | sapwood possible up to 11 %               | healthy sapwood stains, ca. 20-30 %  |
| Color differences | light, naturally permitted                                 | naturally permitted             | permitted                                 | permitted                            |
| Putty color       | dark brown   | dark brown                      | dark brown                                | dark brown                           |

! Wood is a natural product - deviations from the listed grading instructions may occur and do not constitute a defect.

# COUNTRY HOUSE FLOOR-BOARDS 3-LAYER 5G-C 260

AVAILABILITY ON REQUEST



## CONSTRUCTION

Length 1800 | 2000 | 2190 | 2200 | 2300 | 2390 mm  
(no jointed planks)  
ca. 14 mm | top layer (oak) ca. 3 mm (+/-10%)  
middle layer ca. 9 mm | counter tension ca. 2 mm (pine)  
wood moisture 8% (+/-1%)  
4-sided micro bevel | click connection Välinge 5G-C

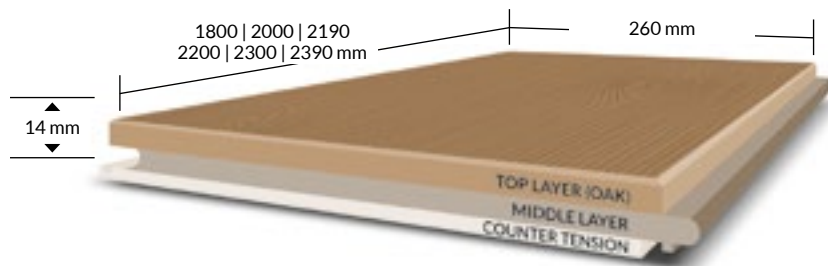

| ARTICLE NO. | PRODUCT DESCRIPTION | DIMENSIONS  | PRICES INCLUDE<br>LIGHT BRUSHING/END OILED |
|-------------|---------------------|---|--|
|             |                     |   | €/m <sup>2</sup> net                       |
| DSP5G14E260 | Oak Elegant*        | 14/3 x 260 x 1800 / 2000 / 2190 / 2200 / 2300 / 2390 mm | 120,29                                     |
| DSP5G14N260 | Oak Natural*        | 14/3 x 260 x 1800 / 2000 / 2190 / 2200 / 2300 / 2390 mm | 103,49                                     |
| DSP5G14M260 | Oak Markant*        | 14/3 x 260 x 1800 / 2000 / 2190 / 2200 / 2300 / 2390 mm | 90,89                                      |
| DSP5G14R260 | Oak Rustic*         | 14/3 x 260 x 1800 / 2000 / 2190 / 2200 / 2300 / 2390 mm | 76,95                                      |

| PACKAGES  | 6 Planks | PU 260 x 1800 = 2,80 m <sup>2</sup> | Palette: 40 Packages = 112,00 m <sup>2</sup> |
|---|----------|-------------------------------------|--|
| <b>EXTRA CHARGE:</b><br>Top layer 4 mm 2,00 €/m <sup>2</sup><br><br>Payment terms according to agreement, delivery and production times depending on order quantity (from 400 m <sup>2</sup> ca. 6-8 weeks) | 6 Planks | PU 260 x 2000 = 3,12 m <sup>2</sup> | Palette: 36 Packages = 112,32 m <sup>2</sup> |
|   | 6 Planks | PU 260 x 2190 = 3,41 m <sup>2</sup> | Palette: 32 Packages = 109,12 m <sup>2</sup> |
|   | 6 Planks | PU 260 x 2200 = 3,43 m <sup>2</sup> | Palette: 32 Packages = 109,76 m <sup>2</sup> |
|   | 6 Planks | PU 260 x 2300 = 3,59 m <sup>2</sup> | Palette: 32 Packages = 114,88 m <sup>2</sup> |
|   | 6 Planks | PU 260 x 2390 = 3,72 m <sup>2</sup> | Palette: 32 Packages = 119,04 m <sup>2</sup> |

\*delivery subject to availability | no length guarantee

## PARQUET OPTIONS IN THE MODULAR PRINCIPLE

### MADE IN GERMANY

All surface treatment and finishing options can be found on page 52 onwards.

### NOTICE FOR SURFACE TREATMENT

\*Staining only in conjunction with oil



|         | ARTICLE NO. | SURFACE TREATMENT & FINISHING                   |           | €/m <sup>2</sup> net |
|---------|-------------|---|-----------|----------------------|
| SURFACE | ST00        | Sanded  | Discount  | -2,56                |
|         | ST01        | Lightly brushed                                 | Included  | 2,56                 |
|         | ST02        | Medium brushed                                  | Surcharge | +0,88                |
|         | ST03        | Strongly brushed                                | Surcharge | +1,76                |
|         | ST05        | Roughly sawn                                    | Surcharge | +3,53                |
| COLOR   | BXXX/FXXX   | Stained and oiled (end oiled, Rubio Monocoat®)* | Surcharge | +5,82                |
|         | FXXX        | Oiled (end oiled) (Rubio Monocoat®)             | Included  | 5,73                 |
|         | FOXX        | Oiled (Osmo 2K Oil)                             | Surcharge | +2,00                |
|         | FRHR        | Raw wood look (Rubio Monocoat®)                 | Surcharge | +6,87                |
|         | FRHS        | Raw wood look (Saicos)                          | Surcharge | +5,00                |
|         | FLAC        | Paint (Saicos)                                  | Surcharge | +6,87                |

| GRADING           | ELEGANT  | NATURAL                         | MARKANT                                   | RUSTIC                               |
|-------------------|--|---------------------------------|---|--------------------------------------|
| Appearance        | harmonious   | calm                            | lively                                    | expressive                           |
| Branches          | point branches and occasional branches up to ca. ø 5-10 mm | healthy branches ca. ø 15-50 mm | branches and edge branches ca. ø 50-70 mm | branches and edge branches available |
| Cracks            | basically free   | small ones possible             | permitted                                 | permitted                            |
| Hairline cracks   | occasionally permitted                                     | occasionally permitted          | permitted                                 | permitted                            |
| Sapwood           | basically free   | basically free                  | sapwood possible up to 11%                | healthy sapwood stains, ca. 20-30%   |
| Color differences | light, naturally permitted                                 | naturally permitted             | permitted                                 | permitted                            |
| Putty color       | dark brown   | dark brown                      | dark brown                                | dark brown                           |

! Wood is a natural product - deviations from the listed grading instructions may occur and do not constitute a defect.

# SURFACE VIEW

## Country House Floorboards 3-layer 5G-C

*Raw material without surface treatment*

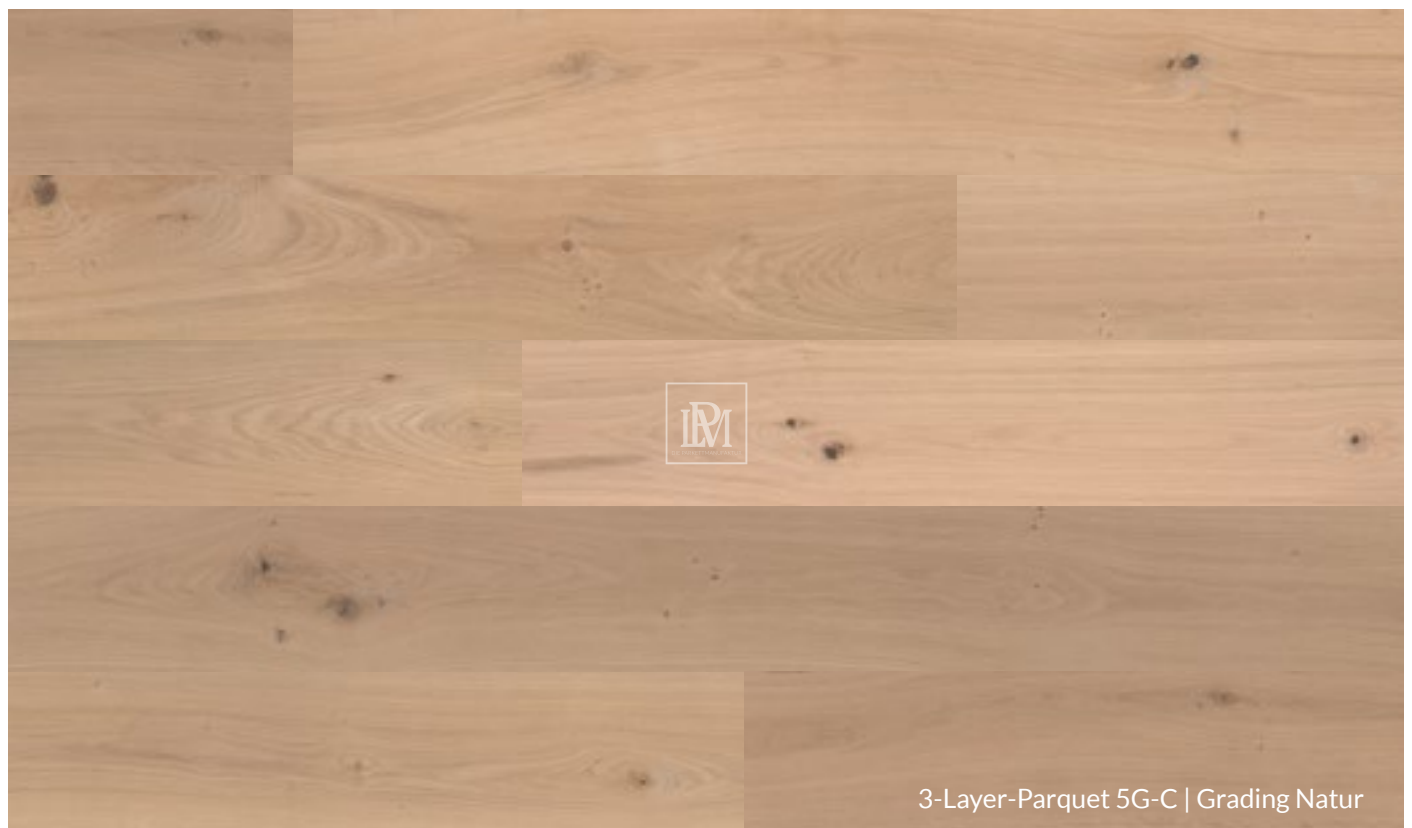
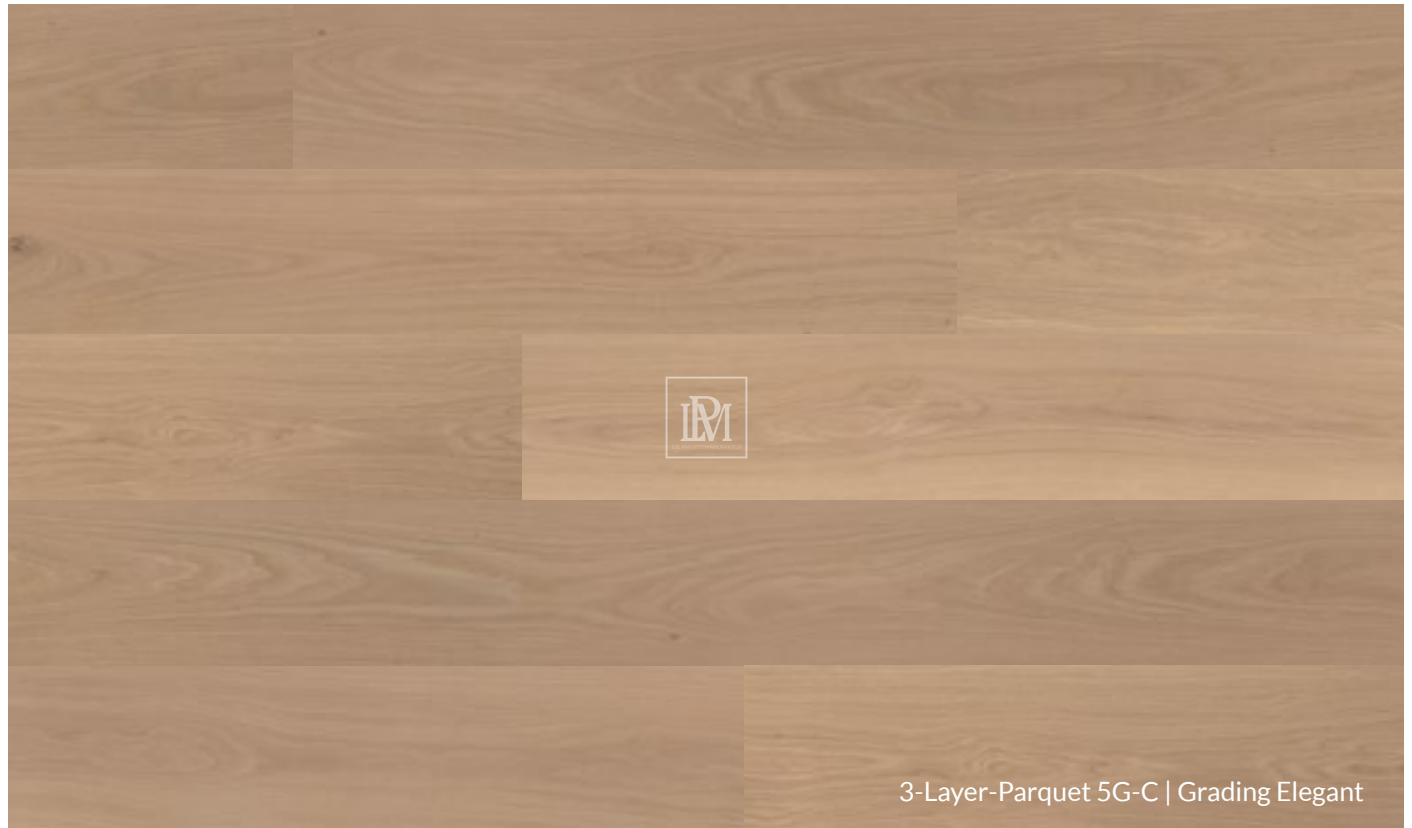

# SURFACE VIEW

## Country House Floorboards 3-layer 5G-C

*Raw material without surface treatment*

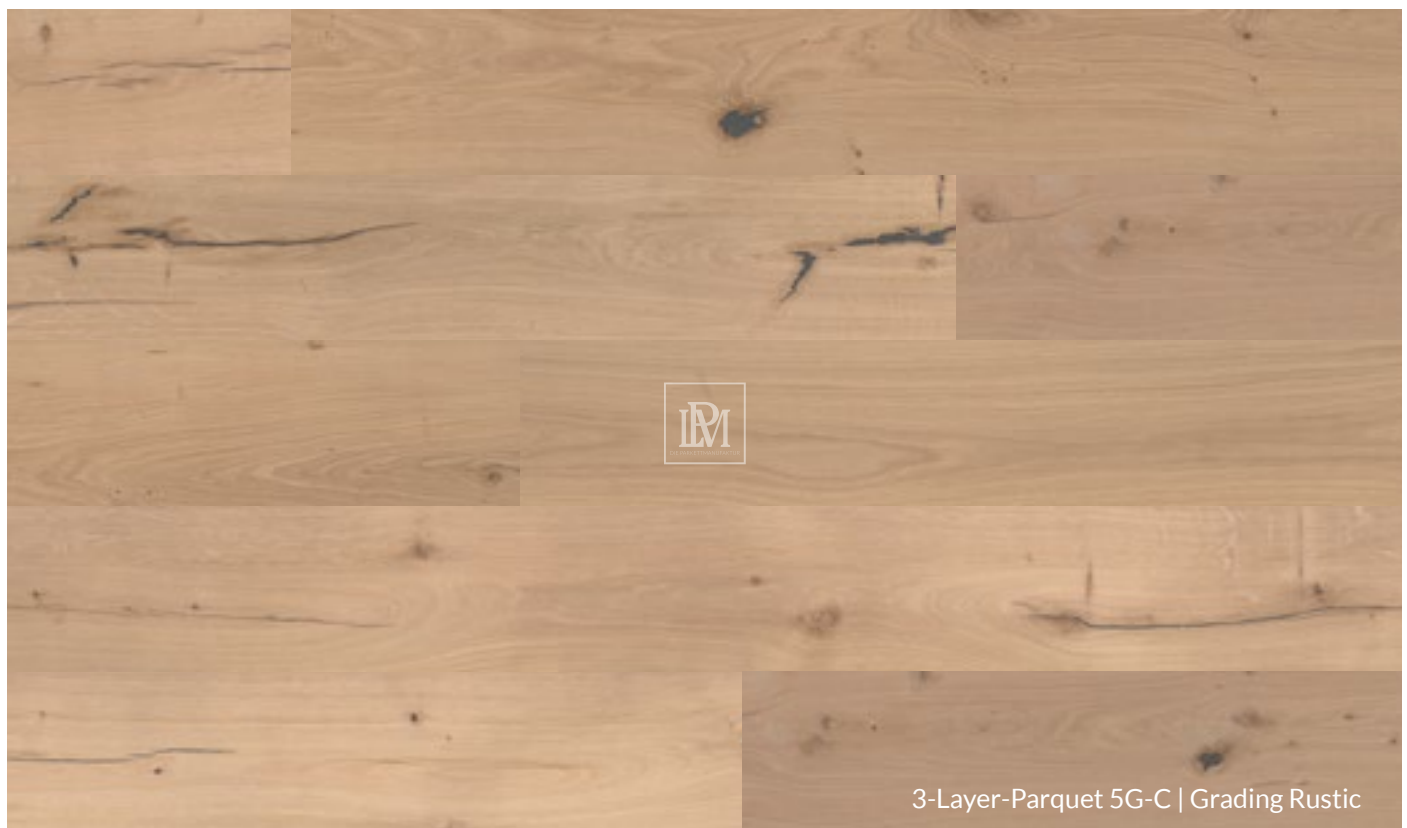
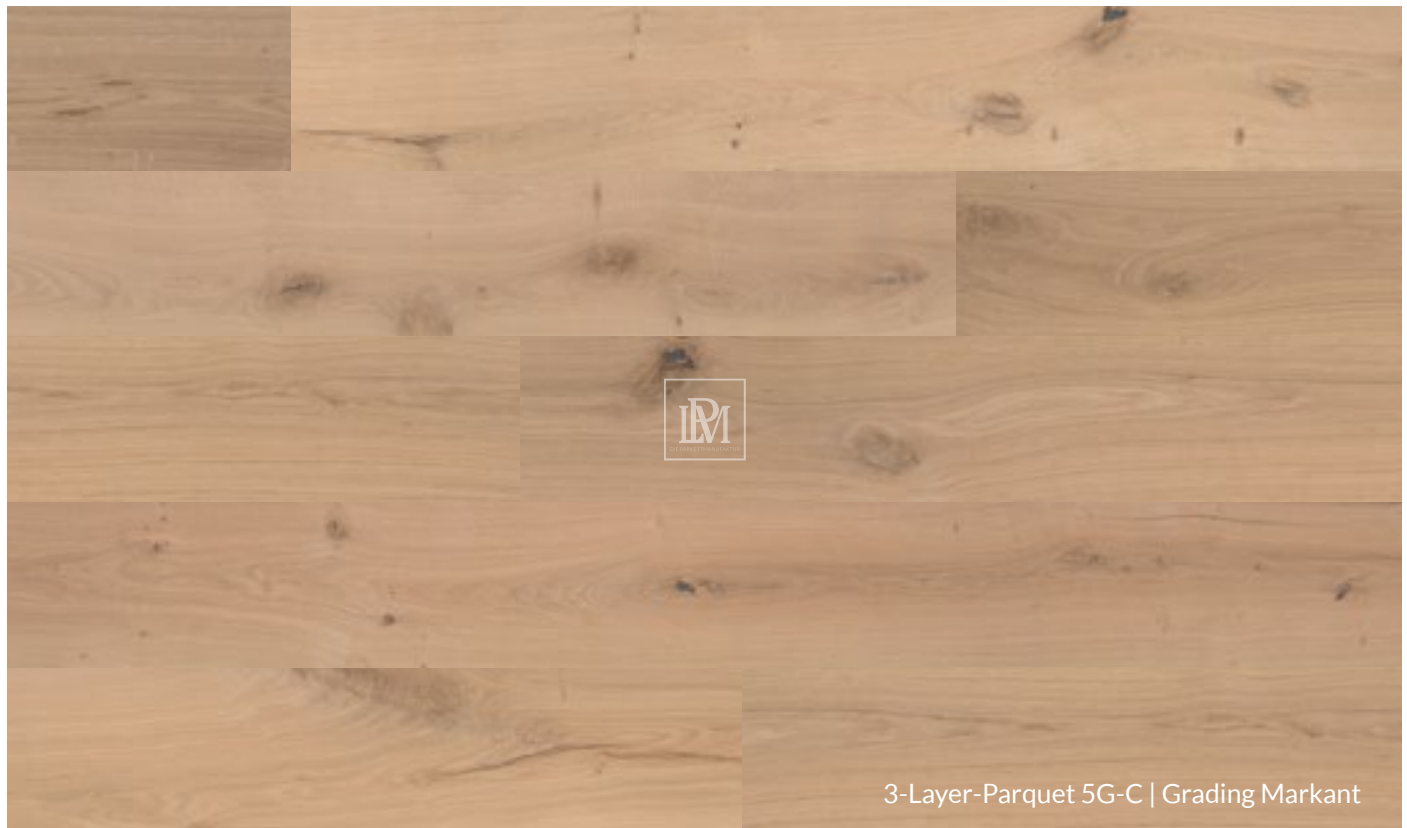

# PARQUET ADHESIVE COLLOFLEX 60

■ 1K SMP PREMIUM-PARQUET ADHESIVE (*firmly elastic*)

**THE ALLROUNDER**

for solid wood, 2 layer and  
3 layer parquet



Manufacturer: Heson GmbH · Sales: LPM GmbH

| ARTICLE NO. | PRODUCT          | COLOR | CONTENTS/<br>CONTAINER | USAGE                     | €/CONTENTS<br>net |
|-------------|------------------|-------|------------------------|---------------------------|-------------------|
| COLLOFLEX60 | Parquet adhesive | Beige | 15 kg                  | 0,7–1,5 kg/m <sup>2</sup> | 103,50            |

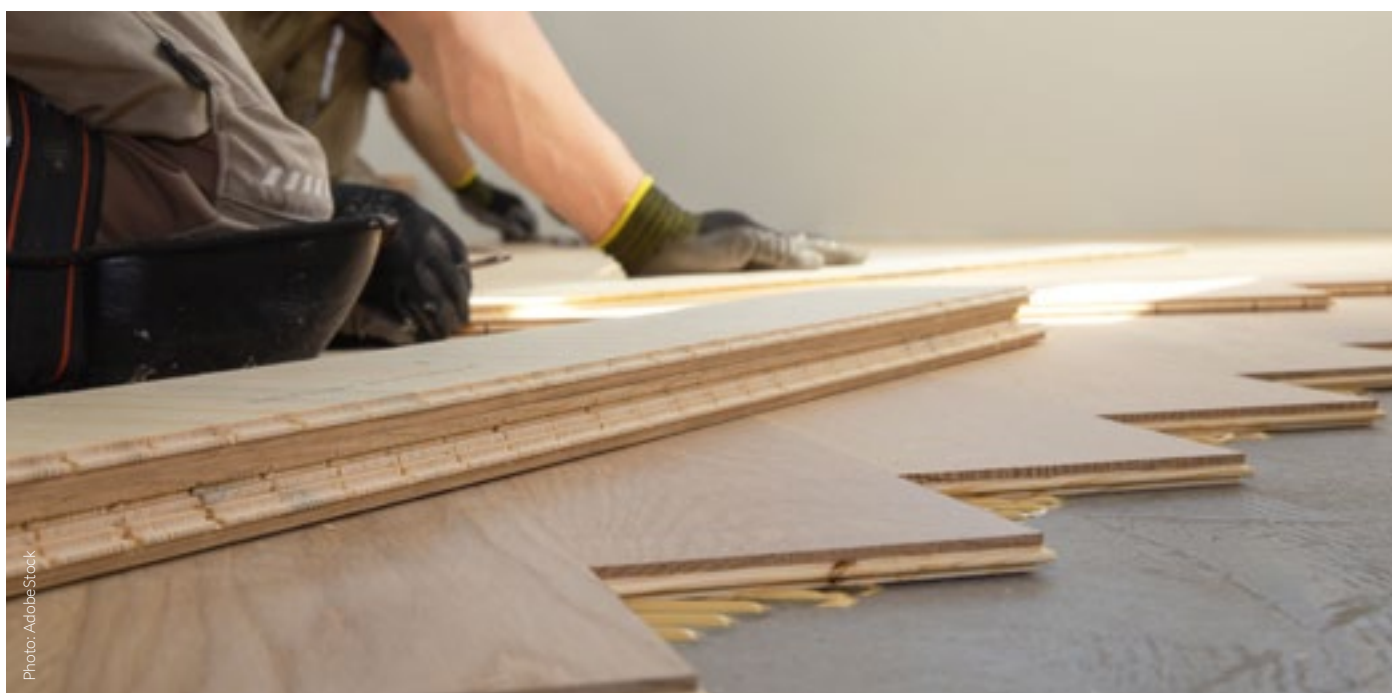

Photo: AdobeStock

Version 1/2024 | Valid from 01. January 2024 | Errors and changes reserved



DESIGN  
LINE





# DESIGNLINE CASTLELINE

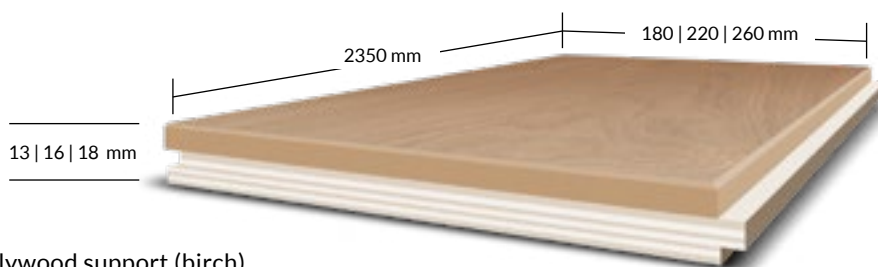

## CONSTRUCTION

plank length 2350 mm

ca. 13 mm | ca. 4 mm top layer (oak) | ca. 9 mm plywood support (birch)

ca. 16 mm | ca. 4 mm top layer (oak) | ca. 12 mm plywood support (birch) – surcharge 4,16 € net

ca. 18 mm | ca. 6 mm top layer (oak) | ca. 12 mm plywood support (birch) – surcharge 10,33 € net

quality according to factory standards | produced analogously according to DIN EN 13489

wood moisture ca. 9 % | edges chamfered 4V | tongue and groove

| ARTICLE NO. | PRODUCT DESCRIPTION            | DIMENSIONS    | PRICES INCLUDE<br>LIGHT BRUSHING/END OILED |
|-------------|--------------------------------|---------------|--|
|             |                                |               | €/m <sup>2</sup> net                       |
| DLCL131801  | Twin 13 Elegant Castleline 180 | 180 x 2350 mm | 167,84 €                                   |
| DLCL131802  | Twin 13 Natural Castleline 180 | 180 x 2350 mm | 161,44 €                                   |
| DLCL131803  | Twin 13 Markant Castleline 180 | 180 x 2350 mm | 150,24 €                                   |
| DLCL131804  | Twin 13 Rustic Castleline 180  | 180 x 2350 mm | 145,44 €                                   |
| DLCL132201  | Twin 13 Elegant Castleline 220 | 220 x 2350 mm | 175,84 €                                   |
| DLCL132202  | Twin 13 Natural Castleline 220 | 220 x 2350 mm | 169,44 €                                   |
| DLCL132203  | Twin 13 Markant Castleline 220 | 220 x 2350 mm | 158,24 €                                   |
| DLCL132204  | Twin 13 Rustic Castleline 220  | 220 x 2350 mm | 153,44 €                                   |
| DLCL132601  | Twin 13 Elegant Castleline 260 | 260 x 2350 mm | 175,84 €                                   |
| DLCL132602  | Twin 13 Natural Castleline 260 | 260 x 2350 mm | 169,44 €                                   |
| DLCL132603  | Twin 13 Markant Castleline 260 | 260 x 2350 mm | 158,24 €                                   |
| DLCL132604  | Twin 13 Rustic Castleline 260  | 260 x 2350 mm | 153,44 €                                   |

FSC®-Certification: available products on request

## PARQUET OPTIONS IN THE MODULAR PRINCIPLE

### MADE IN GERMANY

All surface treatment and finishing options can be found on page 52 onwards.

### NOTICE FOR SURFACE TREATMENT

\*Staining only in conjunction with oil

*Rubio* MONOCOAT

|         | ARTICLE NO. | SURFACE TREATMENT & FINISHING                   |           | €/m <sup>2</sup> net |
|---------|-------------|---|-----------|----------------------|
| SURFACE | ST00        | Sanded  | Discount  | -2,56                |
|         | ST01        | Lightly brushed                                 | Included  | 2,56                 |
|         | ST02        | Medium brushed                                  | Surcharge | +0,88                |
|         | ST03        | Strongly brushed                                | Surcharge | +1,76                |
|         | ST05        | Roughly sawn                                    | Surcharge | +3,53                |
| COLOR   | BXXX/FXXX   | Stained and oiled (end oiled, Rubio Monocoat®)* | Surcharge | +5,82                |
|         | FXXX        | Oiled (end oiled) (Rubio Monocoat®)             | Included  | 5,73                 |
|         | FOXX        | Oiled (Osmo 2K Oil)                             | Surcharge | +2,00                |
|         | FRHR        | Raw wood look (Rubio Monocoat®)                 | Surcharge | +6,87                |
|         | FRHS        | Raw wood look (Saicos)                          | Surcharge | +5,00                |
|         | FLAC        | Paint (Saicos)                                  | Surcharge | +6,87                |

| GRADING           | ELEGANT   | NATURAL                         | MARKANT                             | RUSTIC                               |
|-------------------|---|---------------------------------|-------------------------------------|--------------------------------------|
| Appearance        | harmonious                                      | calm                            | lively                              | expressive                           |
| Branches          | point and isolated branches up to ca. ø 5–10 mm | healthy branches ca. ø 15–45 mm | branches and edge branches probable | branches and edge branches available |
| Cracks            | basically free                                  | basically free                  | few permitted                       | permitted                            |
| Hairline cracks   | occasionally permitted                          | occasionally permitted          | occasionally permitted              | permitted                            |
| Sapwood           | basically free                                  | basically free                  | basically free                      | healthy sapwood ca. 20–30%           |
| Color differences | light, naturally permitted                      | naturally permitted             | permitted                           | permitted                            |
| Putty color       | dark brown                                      | dark brown                      | dark brown                          | dark brown                           |

! Wood is a natural product - deviations from the listed grading instructions may occur and do not constitute a defect.

# SURFACE VIEW

## DESIGNLINE Castleline

Color oil Pure



# DESIGNLINE FISHLINE

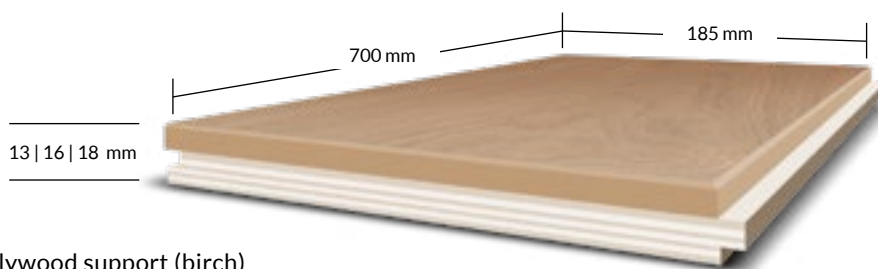

## CONSTRUCTION

plank length 700 mm

ca. 13 mm | ca. 4 mm top layer (oak) | ca. 9 mm plywood support (birch)

ca. 16 mm | ca. 4 mm top layer (oak) | ca. 12 mm plywood support (birch) – surcharge 4,16 € net

ca. 18 mm | ca. 6 mm top layer (oak) | ca. 12 mm plywood support (birch) – surcharge 10,33 € net

quality according to factory standards | produced analogously according to DIN EN 13489

wood moisture ca. 9% | edges chamfered 4V | tongue and groove

| ARTICLE NO. | PRODUCT DESCRIPTION      | DIMENSIONS   | PRICES INCLUDE<br>LIGHT BRUSHING/END OILED |
|-------------|--------------------------|--------------|--|
|             |                          |              | €/m <sup>2</sup> net                       |
| DLFL130001  | Twin 13 Elegant Fishline | 185 x 700 mm | 175,84 €                                   |
| DLFL130002  | Twin 13 Natural Fishline | 185 x 700 mm | 171,04 €                                   |
| DLFL130003  | Twin 13 Markant Fishline | 185 x 700 mm | 167,84 €                                   |
| DLFL130004  | Twin 13 Rustic Fishline  | 185 x 700 mm | 164,64 €                                   |

FSC®-Certification: available products on request

## PARQUET OPTIONS IN THE MODULAR PRINCIPLE

### MADE IN GERMANY

All surface treatment and finishing options can be found on page 52 onwards.

### NOTICE FOR SURFACE TREATMENT

\*Staining only in conjunction with oil

*Rubio* MONOCOAT

|         | ARTICLE NO. | SURFACE TREATMENT & FINISHING                   |           | €/m <sup>2</sup> net |
|---------|-------------|---|-----------|----------------------|
| SURFACE | ST00        | Sanded  | Discount  | -2,56                |
|         | ST01        | Lightly brushed                                 | Included  | 2,56                 |
|         | ST02        | Medium brushed                                  | Surcharge | +0,88                |
|         | ST03        | Strongly brushed                                | Surcharge | +1,76                |
|         | ST05        | Roughly sawn                                    | Surcharge | +3,53                |
| COLOR   | BXXX/FXXX   | Stained and oiled (end oiled, Rubio Monocoat®)* | Surcharge | +5,82                |
|         | FXXX        | Oiled (end oiled) (Rubio Monocoat®)             | Included  | 5,73                 |
|         | FOXX        | Oiled (Osmo 2K Oil)                             | Surcharge | +2,00                |
|         | FRHR        | Raw wood look (Rubio Monocoat®)                 | Surcharge | +6,87                |
|         | FRHS        | Raw wood look (Saicos)                          | Surcharge | +5,00                |
|         | FLAC        | Paint (Saicos)                                  | Surcharge | +6,87                |

| GRADING           | ELEGANT   | NATURAL                         | MARKANT                             | RUSTIC                               |
|-------------------|---|---------------------------------|-------------------------------------|--------------------------------------|
| Appearance        | harmonious                                      | calm                            | lively                              | expressive                           |
| Branches          | point and isolated branches up to ca. ø 5–10 mm | healthy branches ca. ø 15–45 mm | branches and edge branches probable | branches and edge branches available |
| Cracks            | basically free                                  | basically free                  | few permitted                       | permitted                            |
| Hairline cracks   | occasionally permitted                          | occasionally permitted          | occasionally permitted              | permitted                            |
| Sapwood           | basically free                                  | basically free                  | basically free                      | healthy sapwood ca. 20–30%           |
| Color differences | light, naturally permitted                      | naturally permitted             | permitted                           | permitted                            |
| Putty color       | dark brown                                      | dark brown                      | dark brown                          | dark brown                           |



Wood is a natural product - deviations from the listed grading instructions may occur and do not constitute a defect.

# SURFACE VIEW

DESIGNLINE Fishline

Color oil Walnut

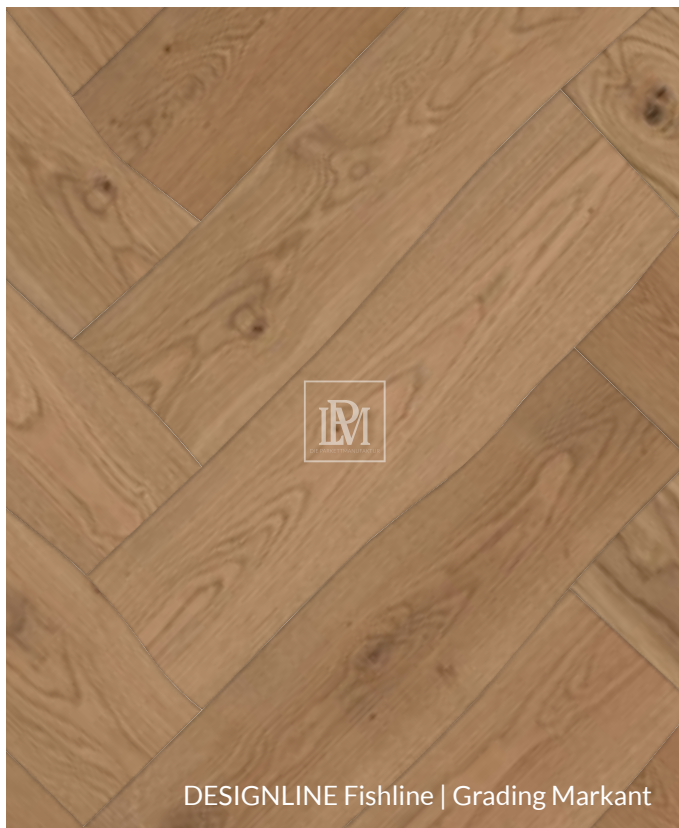

# DESIGNLINE SPINDLE

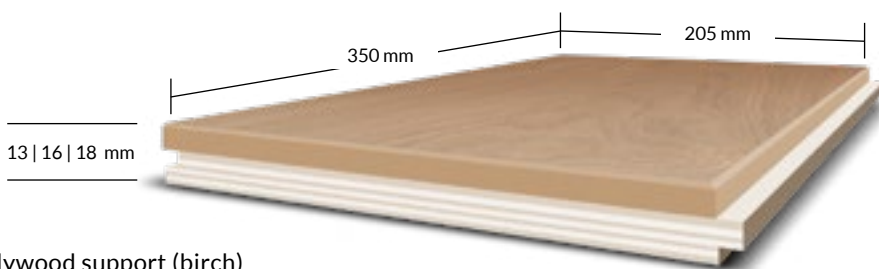

## CONSTRUCTION

parquet tile 205 x 350 mm

ca. 13 mm | ca. 4 mm top layer (oak) | ca. 9 mm plywood support (birch)

ca. 16 mm | ca. 4 mm top layer (oak) | ca. 12 mm plywood support (birch) – surcharge 4,16 € net

ca. 18 mm | ca. 6 mm top layer (oak) | ca. 12 mm plywood support (birch) – surcharge 10,33 € net

quality according to factory standards | produced analogously according to DIN EN 13489

wood moisture ca. 9% | edges chamfered 4V | tongue and groove

| ARTICLE NO. | PRODUCT DESCRIPTION     | DIMENSIONS   | PRICES INCLUDE<br>LIGHT BRUSHING/END OILED |
|-------------|-------------------------|--------------|--|
|             |                         |              | €/m <sup>2</sup> net                       |
| DLSP130001  | Twin 13 Elegant Spindle | 205 x 350 mm | 228,64 €                                   |
| DLSP130002  | Twin 13 Natural Spindle | 205 x 350 mm | 215,84 €                                   |
| DLSP130003  | Twin 13 Markant Spindle | 205 x 350 mm | 211,04 €                                   |
| DLSP130004  | Twin 13 Rustic Spindle  | 205 x 350 mm | 204,64 €                                   |

FSC®-Certification: available products on request

## PARQUET OPTIONS IN THE MODULAR PRINCIPLE

### MADE IN GERMANY

All surface treatment and finishing options can be found on page 52 onwards.

### NOTICE FOR SURFACE TREATMENT

\*Staining only in conjunction with oil



|         | ARTICLE NO. | SURFACE TREATMENT & FINISHING                   |           | €/m <sup>2</sup> net |
|---------|-------------|---|-----------|----------------------|
| SURFACE | ST00        | Sanded  | Discount  | -2,56                |
|         | ST01        | Lightly brushed                                 | Included  | 2,56                 |
|         | ST02        | Medium brushed                                  | Surcharge | +0,88                |
|         | ST03        | Strongly brushed                                | Surcharge | +1,76                |
|         | ST05        | Roughly sawn                                    | Surcharge | +3,53                |
| COLOR   | BXXX/FXXX   | Stained and oiled (end oiled, Rubio Monocoat®)* | Surcharge | +5,82                |
|         | FXXX        | Oiled (end oiled) (Rubio Monocoat®)             | Included  | 5,73                 |
|         | FOXX        | Oiled (Osmo 2K Oil)                             | Surcharge | +2,00                |
|         | FRHR        | Raw wood look (Rubio Monocoat®)                 | Surcharge | +6,87                |
|         | FRHS        | Raw wood look (Saicos)                          | Surcharge | +5,00                |
|         | FLAC        | Paint (Saicos)                                  | Surcharge | +6,87                |

| GRADING           | ELEGANT   | NATURAL                         | MARKANT                             | RUSTIC                               |
|-------------------|---|---------------------------------|-------------------------------------|--------------------------------------|
| Appearance        | harmonious                                      | calm                            | lively                              | expressive                           |
| Branches          | point and isolated branches up to ca. ø 5–10 mm | healthy branches ca. ø 15–45 mm | branches and edge branches probable | branches and edge branches available |
| Cracks            | basically free                                  | basically free                  | few permitted                       | permitted                            |
| Hairline cracks   | occasionally permitted                          | occasionally permitted          | occasionally permitted              | permitted                            |
| Sapwood           | basically free                                  | basically free                  | basically free                      | healthy sapwood ca. 20–30%           |
| Color differences | light, naturally permitted                      | naturally permitted             | permitted                           | permitted                            |
| Putty color       | dark brown                                      | dark brown                      | dark brown                          | dark brown                           |

! Wood is a natural product - deviations from the listed grading instructions may occur and do not constitute a defect.

# SURFACE VIEW

## DESIGNLINE Spindle

Color oil Smoked Oak



DESIGNLINE Spindle | Grading Elegant



DESIGNLINE Spindle | Grading Natural



DESIGNLINE Spindle | Grading Markant



DESIGNLINE Spindle | Grading Rustic

# DESIGNLINE SANDCLOCK

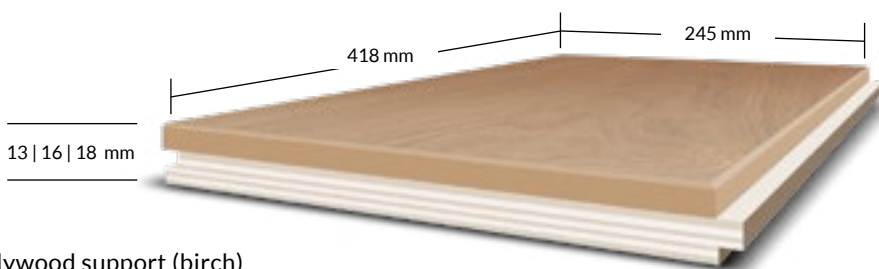

## CONSTRUCTION

parquet tile 245 x 418 mm

ca. 13 mm | ca. 4 mm top layer (oak) | ca. 9 mm plywood support (birch)

ca. 16 mm | ca. 4 mm top layer (oak) | ca. 12 mm plywood support (birch) – surcharge 4,16 € net

ca. 18 mm | ca. 6 mm top layer (oak) | ca. 12 mm plywood support (birch) – surcharge 10,33 € net

quality according to factory standards | produced analogously according to DIN EN 13489

wood moisture ca. 9% | edges chamfered 4V | tongue and groove

| ARTICLE NO. | PRODUCT DESCRIPTION       | DIMENSIONS   | PRICES INCLUDE<br>LIGHT BRUSHING/END OILED |
|-------------|---------------------------|--------------|--|
|             |                           |              | €/m <sup>2</sup> net                       |
| DLSD130001  | Twin 13 Elegant Sandclock | 245 x 418 mm | 228,64 €                                   |
| DLSD130002  | Twin 13 Natural Sandclock | 245 x 418 mm | 215,84 €                                   |
| DLSD130003  | Twin 13 Markant Sandclock | 245 x 418 mm | 211,04 €                                   |
| DLSD130004  | Twin 13 Rustic Sandclock  | 245 x 418 mm | 204,64 €                                   |

FSC®-Certification: available products on request

## PARQUET OPTIONS IN THE MODULAR PRINCIPLE

### MADE IN GERMANY

All surface treatment and finishing options can be found on page 52 onwards.

### NOTICE FOR SURFACE TREATMENT

\*Staining only in conjunction with oil

*Rubio* MONOCOAT

|         | ARTICLE NO. | SURFACE TREATMENT & FINISHING                   |           | €/m <sup>2</sup> net |
|---------|-------------|---|-----------|----------------------|
| SURFACE | ST00        | Sanded  | Discount  | -2,56                |
|         | ST01        | Lightly brushed                                 | Included  | 2,56                 |
|         | ST02        | Medium brushed                                  | Surcharge | +0,88                |
|         | ST03        | Strongly brushed                                | Surcharge | +1,76                |
|         | ST05        | Roughly sawn                                    | Surcharge | +3,53                |
| COLOR   | BXXX/FXXX   | Stained and oiled (end oiled, Rubio Monocoat®)* | Surcharge | +5,82                |
|         | FXXX        | Oiled (end oiled) (Rubio Monocoat®)             | Included  | 5,73                 |
|         | FOXX        | Oiled (Osmo 2K Oil)                             | Surcharge | +2,00                |
|         | FRHR        | Raw wood look (Rubio Monocoat®)                 | Surcharge | +6,87                |
|         | FRHS        | Raw wood look (Saicos)                          | Surcharge | +5,00                |
|         | FLAC        | Paint (Saicos)                                  | Surcharge | +6,87                |

| GRADING           | ELEGANT   | NATURAL                         | MARKANT                             | RUSTIC                               |
|-------------------|---|---------------------------------|-------------------------------------|--------------------------------------|
| Appearance        | harmonious                                      | calm                            | lively                              | expressive                           |
| Branches          | point and isolated branches up to ca. ø 5–10 mm | healthy branches ca. ø 15–45 mm | branches and edge branches probable | branches and edge branches available |
| Cracks            | basically free                                  | basically free                  | few permitted                       | permitted                            |
| Hairline cracks   | occasionally permitted                          | occasionally permitted          | occasionally permitted              | permitted                            |
| Sapwood           | basically free                                  | basically free                  | basically free                      | healthy sapwood ca. 20–30%           |
| Color differences | light, naturally permitted                      | naturally permitted             | permitted                           | permitted                            |
| Putty color       | dark brown                                      | dark brown                      | dark brown                          | dark brown                           |

! Wood is a natural product - deviations from the listed grading instructions may occur and do not constitute a defect.



# SURFACE VIEW

## DESIGNLINE Sandclock

Color oil White 5 %





**P**  
LM

THE PARQUET MANUFACTURER

---

## STAIR NOSING

---

# STAIR NOSING

## Twin-Parquet

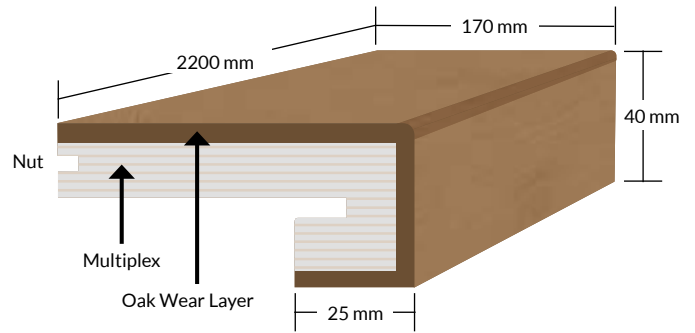

### Block step

#### CONSTRUCTION

Dimensions: 40 x 2200 mm

Undercut: 25 mm

ca. 13 mm | ca. 4 mm top layer (oak) | ca. 9 mm plywood support (birch)

tongue and groove

| ARTICLE NO. | BLOCK STEP  | LENGTH  | UNIT      | PRICES INCLUDE<br>LIGHT BRUSHING/END OILED |
|-------------|-------------|---------|-----------|--|
|             |             |         |           | € net                                      |
| BSTPE180    | Oak Elegant | 2200 mm | per panel | 176,47                                     |
| BSTPN180    | Oak Natural | 2200 mm | per panel | 163,86                                     |
| BSTPM180    | Oak Markant | 2200 mm | per panel | 147,05                                     |
| BSTPR180    | Oak Rustic  | 2200 mm | per panel | 138,65                                     |

! Each step is made by hand. Delivery time is 2-4 weeks.

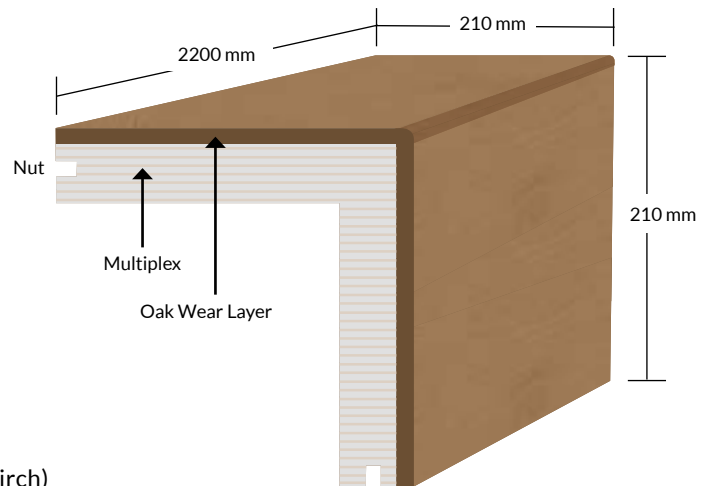

### Angle step

#### CONSTRUCTION

Dimensions: 210/210 x 2200 mm

ca. 13 mm | ca. 4 mm top layer (oak) | ca. 9 mm plywood support (birch)

tongue and groove

| ARTICLE NO. | ANGLE STEP  | LENGTH  | UNIT      | PRICES INCLUDE<br>LIGHT BRUSHING/END OILED |
|-------------|-------------|---------|-----------|--|
|             |             |         |           | € net                                      |
| WSTPE180    | Oak Elegant | 2200 mm | per panel | 176,47                                     |
| WSTPN180    | Oak Natural | 2200 mm | per panel | 163,86                                     |
| WSTPM180    | Oak Markant | 2200 mm | per panel | 147,05                                     |
| WSTPR180    | Oak Rustic  | 2200 mm | per panel | 138,65                                     |

! Each step is made by hand. Delivery time is 2-4 weeks.

! Wood is a natural product - deviations from the listed grading instructions may occur and do not constitute a defect.

# STAIR NOSING

## 3-Layer-Parquet

### Block step

#### CONSTRUCTION

Dimensions: 40 x 2200 mm

Undercut: 25 mm | Nose thickness: 40 mm

14/15 mm | ca. 9 mm spruce/poplar | + 3/4 mm oak | counter tension ca. 2 mm

click connection Välinge 5G-C or dropdown

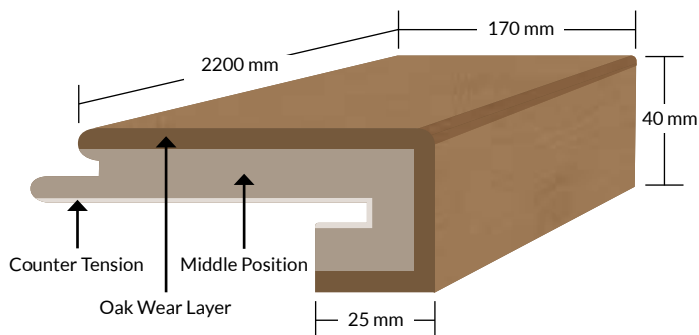

| ARTICLE NO. | BLOCK STEP  | LENGTH  | UNIT      | PRICES INCLUDE<br>LIGHT BRUSHING/END OILED |
|-------------|-------------|---------|-----------|--|
|             |             |         |           | € net                                      |
| BSDSPE180   | Oak Elegant | 2200 mm | per panel | 168,06                                     |
| BSDSPN180   | Oak Natural | 2200 mm | per panel | 155,46                                     |
| BSDSPM180   | Oak Markant | 2200 mm | per panel | 147,05                                     |
| BSDSPR180   | Oak Rustic  | 2200 mm | per panel | 138,65                                     |

! Each step is made by hand. Delivery time is 2-4 weeks.

### Angle step

#### CONSTRUCTION

Dimensions: 250/250 x 2200 mm

14/15 mm | ca. 9 mm spruce/poplar | + 3/4 mm oak | counter tension ca. 2 mm

click connection Välinge 5G-C or dropdown

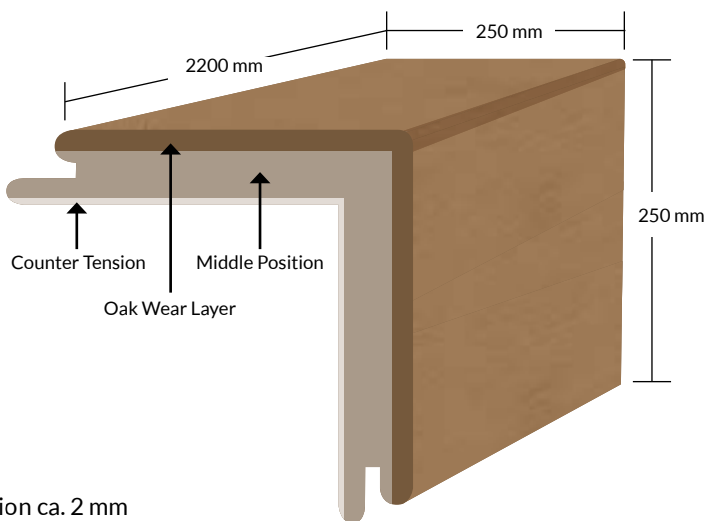

| ARTICLE NO. | ANGLE STEP  | LENGTH  | UNIT      | PRICES INCLUDE<br>LIGHT BRUSHING/END OILED |
|-------------|-------------|---------|-----------|--|
|             |             |         |           | € net                                      |
| WDSPE180    | Oak Elegant | 2200 mm | per panel | 168,06                                     |
| WSDSPN180   | Oak Natural | 2200 mm | per panel | 155,46                                     |
| WSDSPM180   | Oak Markant | 2200 mm | per panel | 147,05                                     |
| WSDSPR180   | Oak Rustic  | 2200 mm | per panel | 138,65                                     |

! Each step is made by hand. Delivery time is 2-4 weeks.

! Wood is a natural product - deviations from the listed grading instructions may occur and do not constitute a defect.

A woman's hands with dark red nail polish are holding a wicker basket filled with various pumpkins and gourds. The basket is placed on a light-colored wooden floor with a diagonal parquet pattern. The woman is wearing a white dress with a colorful floral pattern. The background is a blurred wooden floor.

**IPM**

THE PARQUET MANUFACTURER

---

## SURFACES & FINISHING

---

### WOOD IS A NATURAL PRODUCT.

When treated with stains and/or color oils, color variations may occur due to differences in the surface of the material. These differences in growth, color, structure and grain are natural properties and contribute to the uniqueness and character of the product. Deviations are a part of the nature of this natural product and in no way represent a lack of quality.

All colors shown were applied to oak wood.  
They are indicative and not binding.

# RAW WOOD LOOK

Natural style for your parquet

Rubio<sup>®</sup> MONOCOAT

**Rubio MONOCOAT<sup>®</sup> Invisible Protector** preserves the natural look and structure of your wood. The surface is permanently protected and has a raw wood effect.

The Rubio Invisible Protector is 100 percent plant-based with resins at its core component. A natural raw wood look can be achieved even on deeply brushed parquet floors.

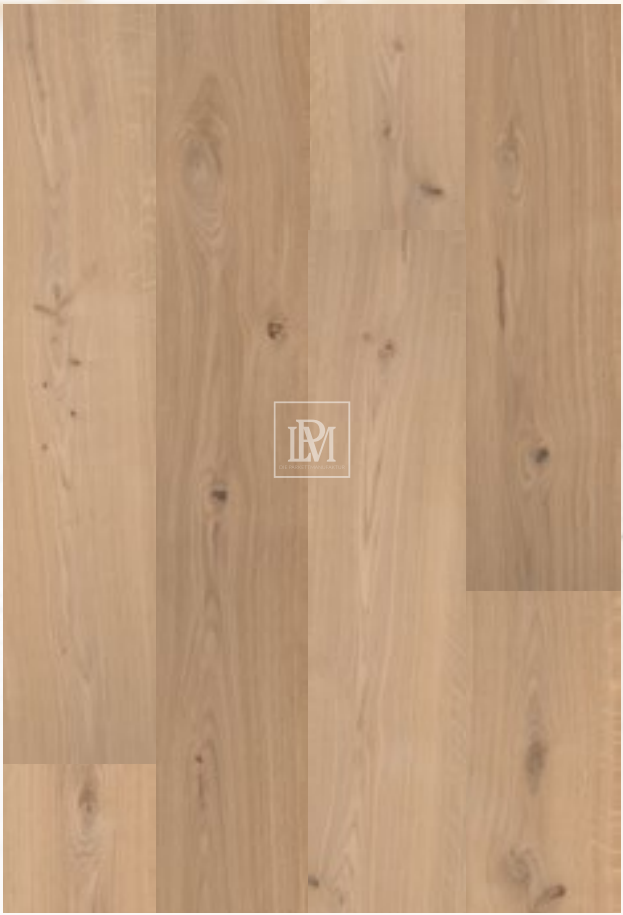

| ARTICLE NO. | SURFACE FINISHING                         | €/m <sup>2</sup> net |
|-------------|---|----------------------|
| FRHR        | Rubio MONOCOAT <sup>®</sup> Raw Wood Look | 12,60                |

Version 1/2024 | Valid from 01. January 2024 | Errors and changes reserved

# OILED SURFACES

For heavily used parquet floors



**Osmo® 2K wood oil** is for all parquet and wooden floors (solid wood floorboards, country house floorboards, ship's flooring, stairs etc.) according to DIN 18356, as well as furniture surfaces. It is particularly suitable for substance rich timber and objects, in which the use of a solvent-free product is required (VOC-free, i.e. free from volatile organic compounds). The wood oil is considered to be an emissions-tested building product according to the principles of the German Institute for Construction Technology (DIBt) under approval number Z-157.10-254.).

Osmo® 2K wood oil is based on renewable raw materials and can be applied with just one quick-drying coat. The treated wood remains open-pored and breathable and at the same time becomes water and dirt repellent. Cleaning and maintaining the oiled surfaces is easy.

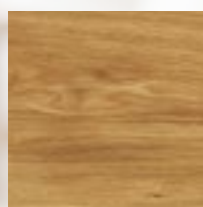

6100 Colorless



6111 White

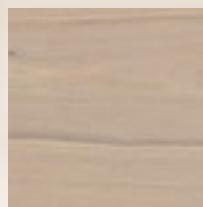

6118 Light Grey

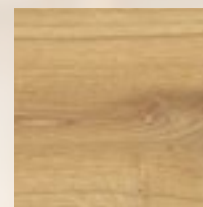

6119 Natura

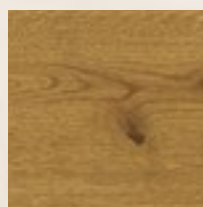

6141 Havanna

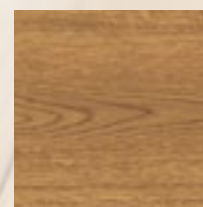

6143 Cognac

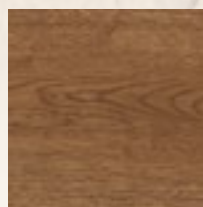

6164 Tobacco

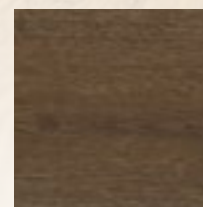

6190 Black

The colors shown are indicative and not binding.

| ARTICLE NO. | SURFACE FINISHING | €/m <sup>2</sup> net |
|-------------|-------------------|----------------------|
| FOXXXX      | Osmo® 2K Wood Oil | 7,73                 |

# RAW WOOD LOOK

Hard wax oil for shiny wooden floors



The **SAICOS® Premium Hard Wax Oil Raw Wood Look** is an open-pored surface treatment based on natural, plant-based raw materials (oils and waxes). The breathable surface coating has been especially developed for all types of wooden floors (according to DIN 18356) as well as for cork floors.

A particularly high penetration capacity enables it to last for a long time. This floor coating protects shiny surfaces with high resistance to wear, even against water aggressive liquids, such as fruit juices according to DIN 48861-C.

SAICOS® Premium hard wax oil surfaces are easy to clean and maintain.

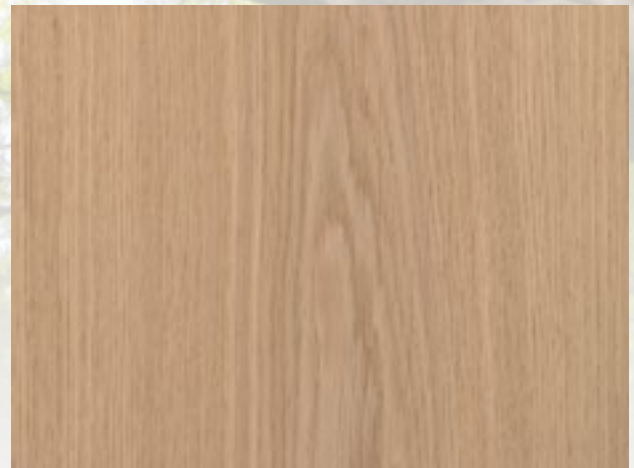

| ARTICLE NO. | SURFACE FINISHING     | €/m <sup>2</sup> net |
|-------------|-----------------------|----------------------|
| FRHS        | Saicos® Raw Wood Look | 10,73                |



# PAINT

For normal and heavily used wooden floors



**SAICOS® Ecoline MultiTop** is a water-based 1K polyurethane sealant for normal and heavily used surfaces.

The sealant is part of a coating system developed specifically for wooden floors as well as for furniture surfaces subjected to particularly heavy wear, which can also be used with Ecoline oil primer and combined with various SAICOS® additives.



| ARTICLE NO. | SURFACE FINISHING | €/m <sup>2</sup> net |
|-------------|-------------------|----------------------|
| FLAC        | Saicos® UV-Paint  | 12,60                |

# SURFACES

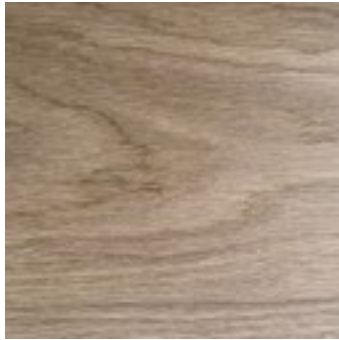

**FINELY  
SANDED.**



**LIGHTLY  
BRUSHED.**

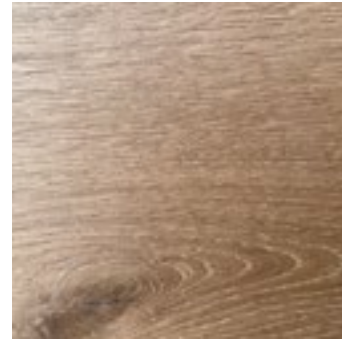

**MEDIUM  
BRUSHED.**



**HEAVILY  
BRUSHED.**



**LOOK  
ROUGH SAWN.**

| ARTICLE NO. | SURFACE FINISHING | €/m <sup>2</sup> net |
|-------------|-------------------|----------------------|
| ST00        | Sanded            | 0,00                 |
| ST01        | Lightly brushed   | 2,56                 |
| ST02        | Medium brushed    | 3,44                 |
| ST03        | Heavily brushed   | 4,32                 |
| ST05        | Rough sawn look   | 6,09                 |

| ARTICLE NO. | SURFACE FINISHING   | €/m <sup>2</sup> net |
|-------------|---|----------------------|
| BXXX-FXXX   | Stained and oiled (end oiled) with Rubio Monocoat® <sup>o</sup> | 11,55                |
| FXXX        | Oiled (end oiled) with Rubio Monocoat®                          | 5,73                 |

<sup>o</sup>Beizen nur in Verbindung mit Öl

# FINISHING

## EFFECT PRE-AGING – STAINING

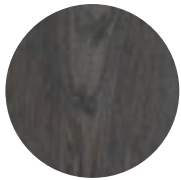

Fumed Intense



Smoke Intense



Authentic 1



Authentic 4



Fumed Pure



Smoke Pure



Authentic 2



Authentic 5



Fumed Light



Smoke Light

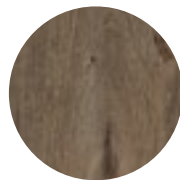

Authentic 3



Authentic 6

The colors shown are indicative and not binding. | Staining only in conjunction with oil.

| ARTICLE NO. | SURFACE FINISHING | €/m <sup>2</sup> net |
|-------------|-------------------|----------------------|
| B000-FXXX   | Without staining  | 0,00                 |
| B001-FXXX   | Fumed Intense     | 11,55                |
| B002-FXXX   | Fumed Light       | 11,55                |
| B003-FXXX   | Fumed Pure        | 11,55                |
| B004-FXXX   | Smoke Intense     | 11,55                |
| B005-FXXX   | Smoke Light       | 11,55                |
| B006-FXXX   | Smoke Pure        | 11,55                |
| B007-FXXX   | Authentic 1       | 11,55                |
| B008-FXXX   | Authentic 2       | 11,55                |
| B009-FXXX   | Authentic 3       | 11,55                |
| B010-FXXX   | Authentic 4       | 11,55                |
| B011-FXXX   | Authentic 5       | 11,55                |
| B012-FXXX   | Authentic 6       | 11,55                |

# NANO-STAINING

*Rubio*® MONOCOAT



**Black**



**Camel**



**Fumed Intense**



**Fumed Light**



**Oak Natural**



**Smoke**



**Teak Brown**



**White**



**White 01**

The colors shown are indicative and not binding. | Staining only in conjunction with oil.

| ARTICLE NO. | SURFACE FINISHING | €/m <sup>2</sup> net |
|-------------|-------------------|----------------------|
| B013-FXXX   | Black             | 11,55                |
| B014-FXXX   | Camel             | 11,55                |
| B015-FXXX   | Fumed Intense     | 11,55                |
| B016-FXXX   | Fumed Light       | 11,55                |
| B017-FXXX   | Oak Natural       | 11,55                |
| B018-FXXX   | Smoke             | 11,55                |
| B019-FXXX   | Teak Brown        | 11,55                |
| B020-FXXX   | White             | 11,55                |
| B021-FXXX   | White 01          | 11,55                |

# COLOR OILS (1)

Rubio<sup>®</sup> MONOCOAT



**Antique Bronze  
F001**



**Aqua  
F002**

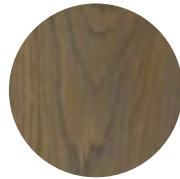

**Ash Grey  
F003**



**Biscuit  
F004**

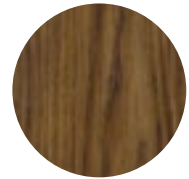

**Black  
F005**



**Bourbon  
F006**



**Castle Brown  
F007**

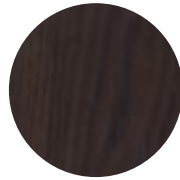

**Charcoal  
F008**



**Cherry Coral  
F009**

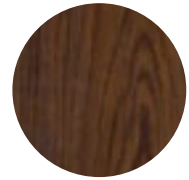

**Chocolate  
F010**



**Cornsilk  
F011**



**Cotton White  
F012**



**Dark Oak  
F013**

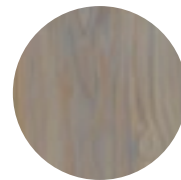

**Gris Beige  
F014**



**Havanna  
F015**

The colors shown are indicative and not binding.

| ARTICLE NO. | SURFACE FINISHING | €/m <sup>2</sup> net |
|-------------|-------------------|----------------------|
| F001        | Antique Bronze    | 5,73                 |
| F002        | Aqua              | 5,73                 |
| F003        | Ash Grey          | 5,73                 |
| F004        | Biscuit           | 5,73                 |
| F005        | Black             | 5,73                 |
| F006        | Bourbon           | 5,73                 |
| F007        | Castle Brown      | 5,73                 |
| F008        | Charcoal          | 5,73                 |
| F009        | Cherry Coral      | 5,73                 |
| F010        | Chocolate         | 5,73                 |
| F011        | Cornsilk          | 5,73                 |
| F012        | Cotton White      | 5,73                 |
| F013        | Dark Oak          | 5,73                 |
| F014        | Gris Beige        | 5,73                 |
| F015        | Havanna           | 5,73                 |

## COLOR OILS (2)

Rubio MONOCOAT



Ice Brown  
F016



Mahogany  
F017



Mist  
F018



Mist 5%  
F019



Mud Light  
F020



Natural  
F021



Oak  
F022



Olive  
F023



Oyster  
F024



Pine  
F025



Pure  
F026



Savanna  
F027



Silver Grey  
F028

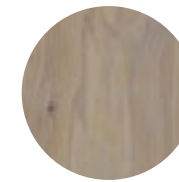

Sky Grey  
F029



Slate Grey  
F030

The colors shown are indicative and not binding.

| ARTICLE NO. | SURFACE FINISHING | €/m <sup>2</sup> net |
|-------------|-------------------|----------------------|
| F016        | Ice Brown         | 5,73                 |
| F017        | Mahogany          | 5,73                 |
| F018        | Mist              | 5,73                 |
| F019        | Mist 5 %          | 5,73                 |
| F020        | Mud Light         | 5,73                 |
| F021        | Natural           | 5,73                 |
| F022        | Oak               | 5,73                 |
| F023        | Olive             | 5,73                 |
| F024        | Oyster            | 5,73                 |
| F025        | Pine              | 5,73                 |
| F026        | Pure              | 5,73                 |
| F027        | Savanna           | 5,73                 |
| F028        | Silver Grey       | 5,73                 |
| F029        | Sky Grey          | 5,73                 |
| F030        | Slate Grey        | 5,73                 |

## COLOR OILS (3)

Rubio MONOCOAT



Smoke  
F031



Smoke 5%  
F032



Smoked Oak  
F033



Stone  
F034



Super White  
F035



Titanium Grey  
F036



Vanilla  
F037



Walnut  
F038



White  
F039



White 5%  
F040

The colors shown are indicative and not binding.

### COLOR AND PROTECT NATURALLY WITH RUBIO MONOCOAT®

Rubio Monocoat® color oils color and protect parquet with just a single layer. They are based on linseed oil and consist of 100% natural ingredients. They are free of water and solvents and contain 0% VOC.

| ARTICLE NO. | SURFACE FINISHING | €/m <sup>2</sup> net |
|-------------|-------------------|----------------------|
| F031        | Smoke             | 5,73                 |
| F032        | Smoke 5 %         | 5,73                 |
| F033        | Smoked Oak        | 5,73                 |
| F034        | Stone             | 5,73                 |
| F035        | Super White       | 5,73                 |
| F036        | Titanium Grey     | 5,73                 |
| F037        | Vanilla           | 5,73                 |
| F038        | Walnut            | 5,73                 |
| F039        | White             | 5,73                 |
| F040        | White 5 %         | 5,73                 |

## COLOR OILS (4)

Rubio<sup>®</sup> MONOCOAT

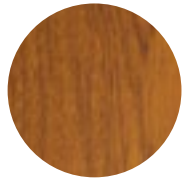

Cinamon Brown  
F041



Nordic Blue  
F042



Morning Mist  
F043



Velvet Green  
F044



Touch of Gold  
F045

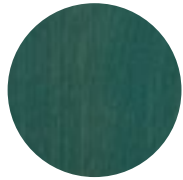

Peacock Green  
F046



Rusty Brown  
F047



Midnight Indigo  
F048

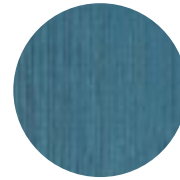

Teal Blue  
F049



Pomegranate Pink  
F050

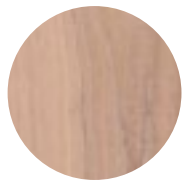

Winter Blush  
F051



Frost Green  
F052



Heather Purple  
F053



Crudo  
F060

The colors shown are indicative and not binding.

| ARTICLE NO. | SURFACE FINISHING | €/m <sup>2</sup> net |
|-------------|-------------------|----------------------|
| F041        | Cinamon Brown     | 5,73                 |
| F042        | Nordic Blue       | 5,73                 |
| F043        | Morning Mist      | 5,73                 |
| F044        | Velvet Green      | 5,73                 |
| F045        | Touch of Gold     | 5,73                 |
| F046        | Peacock Green     | 5,73                 |
| F047        | Rusty Brown       | 5,73                 |
| F048        | Midnight Indigo   | 5,73                 |
| F049        | Teal Blue         | 5,73                 |
| F050        | Pomegranate Pink  | 5,73                 |
| F051        | Winter Blush      | 5,73                 |
| F052        | Frost Green       | 5,73                 |
| F053        | Heather Purple    | 5,73                 |
| F060        | Crudo             | 5,73                 |





IPM

THE PARQUET MANUFACTURER

CLEANING & CARE

# CLEANING & CARE

## ■ RUBIO MONOCOAT® - CLEANING AND CARE PRODUCTS

Proper cleaning is the basis for beautiful and durable surfaces. Particularly important is a universal applicability. Both the RMC soap and the RMC care oils are also suitable for freshening up all natural surfaces.

The RMC Tannin Remover removes stains on wood containing tannic acid, including rings/ stains from drink cans, flower pots and urine.



! To maintain and refresh RMC colored oiled surfaces, we recommend using RMC Maintenance Oil (Pure) 0.50 L with the addition of RMC Oil Plus 0.10 L in the desired RMC color.

| ARTICLE NO.     | PRODUCT                             | COLOR TONE | CONTENT/CONTAINER | CONSUMPTION/RANGE         | €/CONTAINER net |
|-----------------|-------------------------------------|------------|-------------------|---------------------------|-----------------|
| <b>CARE OIL</b> |                                     |            |                   |                           |                 |
| 702219          | RMC Maintenance Oil (care oil)      | White      | 0,5 L             | ca. 75–100 m <sup>2</sup> | 46,97           |
| 702114          | RMC Maintenance Oil (care oil)      | Pure       | 0,5 L             | ca. 75–100 m <sup>2</sup> | 46,97           |
| <b>CLEANER</b>  |                                     |            |                   |                           |                 |
| 702104          | RMC Soap Universal                  |            | 1,00 L            | ca. 500 m <sup>2</sup>    | 15,88           |
| 702105          | RMC Soap Universal                  |            | 2,00 L            | ca. 1000 m <sup>2</sup>   | 28,49           |
| 702106          | RMC Surface Care (soap spray)       |            | 0,75 L            | as required               | 17,56           |
| 702107          | RMC Tannin Remover (cleaning spray) |            | 0,50 L            | as required               | 34,37           |



---

## POINT OF SALE

---



# YOUR POINT OF SALE POSSIBILITIES



We are more than happy to provide you with our **POS brochure** with all of our currently available advertising materials. In addition to our own brand Glan-Park® we also provide the option of creating **your own branding**.

**Talk to our team -  
Contact details can be found on the back.**



Abbildungen ähnlich

# OUR GENERAL TERMS AND CONDITIONS ARE AVAILABLE HERE:

[www.lpm-parkett.de/en/general-terms-and-conditions/](http://www.lpm-parkett.de/en/general-terms-and-conditions/)



## DELIVERY TERMS

### FREIGHT CONDITIONS (SHIPPING GERMANY – MAINLAND)

From a net value of goods from EUR 1,000.00 we deliver for a logistics fee of 24.95 EUR to storage facilities. Delivery to construction sites and end users is carried out for a flat rate of EUR 169.00 (plus EUR 12.95 Avis). With a net goods value of less than 1,000.00 EUR we will send the goods with a follow-up order or calculate any shipping costs incurred a flat rate of EUR 79.90.

Freight costs to neighboring countries are available on request.

Delivery to construction sites and private addresses can only be guaranteed if there is an adequate surface for storing the goods, i.e. an asphalted or paved area.

### TERMS OF PAYMENT

available on request





# PACKAGING UNITS

| Article   | Packaging Material | Thickness in mm | Width in mm | Length in mm | Number Planks   Tiles              | m <sup>2</sup> | PPP | PPU    |
|---|--------------------|-----------------|-------------|--------------|------------------------------------|----------------|-----|--------|
| 3-Layer-Parquet 5G-C                                  | Foil + Bandrole    | 14              | 190         | 2190         | 8                                  | 3,33           | 32  | 106,56 |
| 3-Layer-Parquet 5G-C                                  | Foil + Bandrole    | 14              | 190         | 2390         | 8                                  | 3,63           | 32  | 116,16 |
| 3-Layer-Parquet 5G-C                                  | Foil + Bandrole    | 14              | 190         | 1800         | 8                                  | 2,73           | 40  | 109,20 |
| 3-Layer-Parquet 5G-C                                  | Foil + Bandrole    | 14              | 190         | 2000         | 8                                  | 3,04           | 36  | 109,44 |
| 3-Layer-Parquet 5G-C                                  | Foil + Bandrole    | 14              | 190         | 2200         | 8                                  | 3,34           | 32  | 106,88 |
| 3-Layer-Parquet 5G-C                                  | Foil + Bandrole    | 14              | 190         | 2300         | 8                                  | 3,49           | 32  | 111,68 |
| 3-Layer-Parquet 5G-C                                  | Foil + Bandrole    | 14              | 220         | 2190         | 6                                  | 2,89           | 36  | 104,04 |
| 3-Layer-Parquet 5G-C                                  | Foil + Bandrole    | 14              | 220         | 2390         | 6                                  | 3,15           | 32  | 100,80 |
| 3-Layer-Parquet 5G-C                                  | Foil + Bandrole    | 14              | 220         | 1800         | 8                                  | 3,16           | 36  | 113,76 |
| 3-Layer-Parquet 5G-C                                  | Foil + Bandrole    | 14              | 220         | 2000         | 8                                  | 3,52           | 32  | 112,64 |
| 3-Layer-Parquet 5G-C                                  | Foil + Bandrole    | 14              | 220         | 2200         | 6                                  | 2,90           | 36  | 104,40 |
| 3-Layer-Parquet 5G-C                                  | Foil + Bandrole    | 14              | 220         | 2300         | 6                                  | 3,03           | 36  | 109,08 |
| 3-Layer-Parquet 5G-C                                  | Foil + Bandrole    | 14              | 260         | 2190         | 6                                  | 3,41           | 32  | 109,12 |
| 3-Layer-Parquet 5G-C                                  | Foil + Bandrole    | 14              | 260         | 2390         | 6                                  | 3,72           | 32  | 119,04 |
| 3-Layer-Parquet 5G-C                                  | Foil + Bandrole    | 14              | 260         | 1800         | 6                                  | 2,80           | 40  | 112,00 |
| 3-Layer-Parquet 5G-C                                  | Foil + Bandrole    | 14              | 260         | 2000         | 6                                  | 3,12           | 36  | 112,32 |
| 3-Layer-Parquet 5G-C                                  | Foil + Bandrole    | 14              | 260         | 2200         | 6                                  | 3,43           | 32  | 109,76 |
| 3-Layer-Parquet 5G-C                                  | Foil + Bandrole    | 14              | 260         | 2300         | 6                                  | 3,59           | 32  | 114,88 |
| Twin-Parquet-10                                       | Foil + Bandrole    | 10              | 180         | 1800-2400    | 8                                  |                |     | 90-100 |
| Twin-Parquet-13                                       | Foil + Bandrole    | 13              | 140         | 1800-2400    | 8                                  |                |     | 90-100 |
| Twin-Parquet-13                                       | Foil + Bandrole    | 13              | 180         | 1800-2400    | 8                                  |                |     | 90-100 |
| Twin-Parquet-13                                       | Foil + Bandrole    | 13              | 220         | 1800-2400    | 6                                  |                |     | 90-100 |
| Twin-Parquet-13                                       | Foil + Bandrole    | 13              | 260         | 1800-2400    | 6                                  |                |     | 90-100 |
| Twin-Parquet-18                                       | Foil + Bandrole    | 18              | 140         | 1800-2400    | 8                                  |                |     | 90-100 |
| Twin-Parquet-18                                       | Foil + Bandrole    | 18              | 180         | 1800-2400    | 6                                  |                |     | 90-100 |
| Twin-Parquet-18                                       | Foil + Bandrole    | 18              | 220         | 1800-2400    | 6                                  |                |     | 90-100 |
| Twin-Strip-Parquet-10                                 | Carton             | 10              | 120         | 600          | 40 (each 20 right and left strips) | 2,88           | 36  | 103,68 |
| Twin-Strip-Parquet-10                                 | Carton             | 10              | 140         | 700          | 40 (each 20 right and left strips) | 3,92           | 24  | 94,08  |
| Twin-Strip-Parquet-13                                 | Carton             | 13              | 120         | 600          | 30 (each 15 right and left strips) | 2,16           | 36  | 77,76  |
| Twin-Strip-Parquet-13                                 | Carton             | 13              | 140         | 700          | 30 (each 15 right and left strips) | 2,94           | 24  | 70,56  |
| Twin-Strip-Parquet-16                                 | Carton             | 16              | 120         | 600          | 26 (each 13 right and left strips) | 2,54           | 36  | 91,44  |
| Twin-Strip-Parquet-16                                 | Carton             | 16              | 140         | 700          | 26 (each 13 right and left strips) | 2,54           | 24  | 60,96  |
| Glanwood  | Foil               | 16              | 180         | 1500-2400    | 6                                  |                |     | 90-100 |
| Glanwood  | Foil               | 16              | 220         | 1500-2400    | 6                                  |                |     | 90-100 |
| Glanwood  | Foil               | 16              | 260         | 1500-2400    | 6                                  |                |     | 90-100 |
| Glanwood Strip-Parquet                                | Carton             | 16              | 140         | 700          | 26 (each 13 right and left strips) | 2,55           | 24  | 61,20  |
| Solid-Wood-Parquet                                    | Foil               | 15   20         | 140         | 500-2400     | 6                                  |                |     | 90-100 |
| Solid-Wood-Parquet                                    | Foil               | 15   20         | 160         | 500-2400     | 6   8                              |                |     | 90-100 |
| Solid-Wood-Parquet                                    | Foil               | 20              | 180         | 500-2400     | 6                                  |                |     | 90-100 |
| Solid-Wood-Parquet                                    | Foil               | 20              | 220         | 500-2400     | 6                                  |                |     | 90-100 |
| Solid-Wood-Strip-Parquet                              | Carton             | 20              | 140         | 700          | 20 (each 10 right and left strips) | 1,96           | 24  | 47,04  |
| TRIO 3-Layer-Strip-Parquet Herringbone 90°            | Carton             | 11              | 137         | 600          | 36 (each 18 right and left strips) | 2,96           | 36  | 106,56 |
| TRIO 3-Layer-Strip-Parquet Herringbone 90° (Object)   | Carton             | 11              | 80          | 580          | 54 (each 27 right and left strips) | 2,51           | 36  | 90,36  |
| TRIO 3-Layer-Strip-Parquet French Herringbone Chevron | Foil               | 11              | 137         | 600          | 36 (each 18 right and left strips) | 2,96           | 36  | 106,56 |
| DESIGNLINE Castleline                                 | Foil               | 13              | 180         | 2350         | each 2xA   2xB   2xC               | 2,09           |     | 80-90  |
| DESIGNLINE Castleline                                 | Foil               | 13              | 220         | 2350         | each 2xA   2xB   2xC               | 2,65           |     | 80-90  |
| DESIGNLINE Castleline                                 | Foil               | 13              | 260         | 2350         | each 2xA   2xB   2xC               | 3,20           |     | 80-90  |
| DESIGNLINE Fishline                                   | Foil               | 13              | 185         | 700          | 16 (each 8 right and left strips)  | 1,56           |     | 80-90  |
| DESIGNLINE Spindle                                    | Foil               | 13              | 205         | 350          | 16                                 | 0,66           |     | 80-90  |
| DESIGNLINE Sandclock                                  | Foil               | 13              | 245         | 418          | 16                                 | 0,96           |     | 80-90  |



## LPM GmbH

Zeppelinstraße 3

21337 Lüneburg

**T** +49 (0)4131 9276999

**F** +49 (0)4131 9276998

**M** info@lpm-parkett.de

**www.lpm-parkett.de**

 @lpmparkettmanufaktur

 @lpm\_parkettmanufaktur

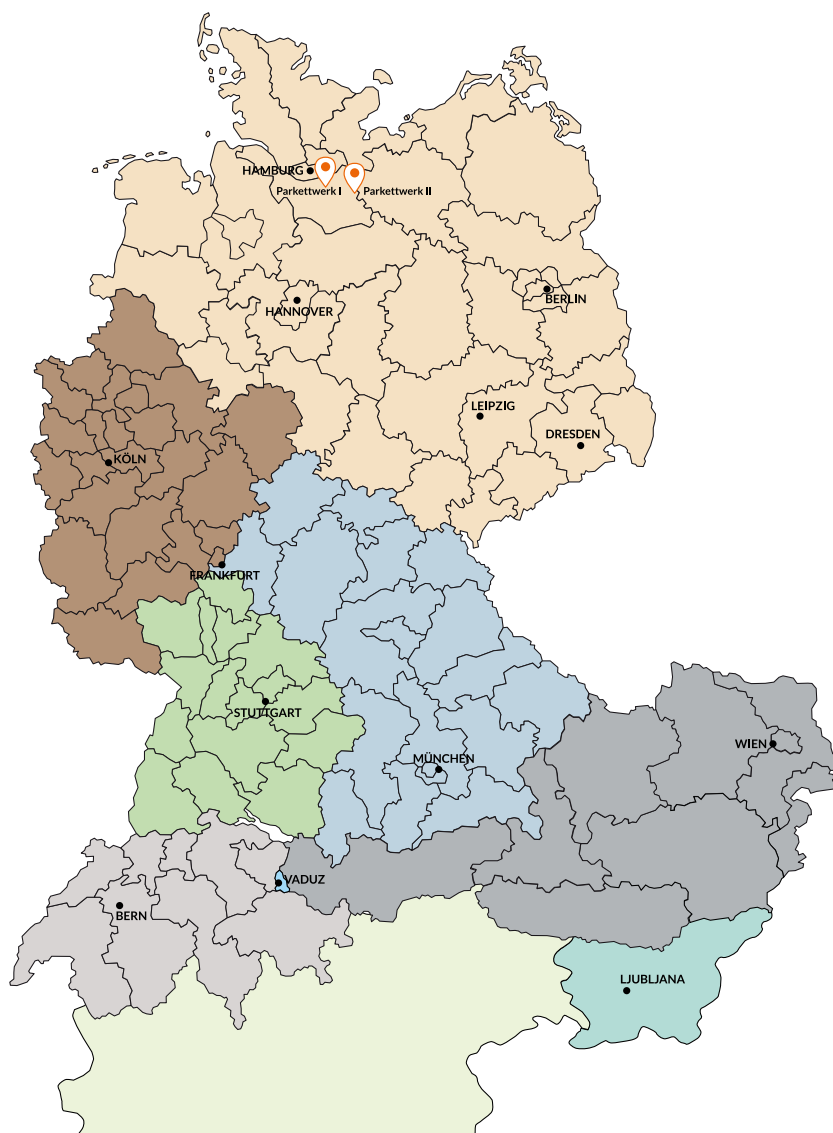

## CONTACT PERSON SALES

 **NORTH/EAST**  
**Dirk Mischke**  
Zip code area: 01-04 | 06-09 |  
10-33 | 37-39 | 49 | 99  
**E** mischke@lpm-parkett.de  
**T** +49 (0)176 46558640

 **WEST**  
**Henrike Altrogge**  
Zip code area: 34-35 | 40-48 |  
50-59 | 60-61 | 65-66  
**E** altrogge@lpm-parkett.de  
**T** +49 (0)174 3808844

 **SOUTH/WEST**  
**Andreas Reicherter**  
Zip code area:  
64 | 67-79 | 88-89  
**E** reicherter@lpm-parkett.de  
**T** +49 (0)1512 7000864

 **SOUTH/EAST**  
**Axel Schindewolf**  
Zip code area:  
36 | 62-63 | 80-87 | 90-98  
**E** schindewolf@lpm-parkett.de  
**T** +49 (0)175 2433482

 **AUSTRIA / SWITZERLAND / ITALY  
LICHTENSTEIN / SLOVENIA**  
**Max Reissecker**  
**E** reissecker@lpm-parkett.de  
**T** +43 (0)664 3556606